

# OWNER'S MANUAL

## MODEL NO. MC1538ST (MC1538STA)

### 15.0 HP 38 Inch Lawn Tractor

- **Assembly**
  - **Operation**
  - **Maintenance**
    - **Service and Adjustments**
    - **Storage**
      - **Troubleshooting**
      - **Repair Parts**

For Parts and Service, contact our authorized distributor: call 1-800-849-1297  
For Technical Assistance: call 1-800-829-5886

---

# **McCULLOCH**®



# SAFETY RULES



## Safe Operation Practices for Ride-On Mowers

**IMPORTANT:** THIS CUTTING MACHINE IS CAPABLE OF AMPUTATING HANDS AND FEET AND THROWING OBJECTS. FAILURE TO OBSERVE THE FOLLOWING SAFETY INSTRUCTIONS COULD RESULT IN SERIOUS INJURY OR DEATH.



**WARNING:** In order to prevent accidental starting when setting up, transporting, adjusting or making repairs, always disconnect spark plug wire and place wire where it cannot contact spark plug.



**WARNING:** Do not coast down a hill in neutral, you may lose control of the tractor.



**WARNING:** Tow only the attachments that are recommended by and comply with specifications of the manufacturer of your tractor. Use common sense when towing. Operate only at the lowest possible speed when on a slope. Too heavy of a load, while on a slope, is dangerous. Tires can lose traction with the ground and cause you to lose control of your tractor.

### I. GENERAL OPERATION

- Read, understand, and follow all instructions on the machine and in the manual before starting.
- Do not put hands or feet near rotating parts or under the machine. Keep clear of the discharge opening at all times.
- Only allow responsible adults, who are familiar with the instructions, to operate the machine.
- Clear the area of objects such as rocks, toys, wire, etc., which could be picked up and thrown by the blades.
- Be sure the area is clear of bystanders before operating. Stop machine if anyone enters the area.
- Never carry passengers.
- Do not mow in reverse unless absolutely necessary. Always look down and behind before and while backing.
- Never direct discharged material toward anyone. Avoid discharging material against a wall or obstruction. Material may ricochet back toward the operator. Stop the blades when crossing gravel surfaces.
- Do not operate machine without the entire grass catcher, discharge guard, or other safety devices in place and working.
- Slow down before turning.
- Never leave a running machine unattended. Always turn off blades, set parking brake, stop engine, and remove keys before dismounting.

- Disengage blades when not mowing. Shut off engine and wait for all parts to come to a complete stop before cleaning the machine, removing the grass catcher, or unclogging the discharge guard.
- Operate machine only in daylight or good artificial light.
- Do not operate the machine while under the influence of alcohol or drugs.
- Watch for traffic when operating near or crossing roadways.
- Use extra care when loading or unloading the machine into a trailer or truck.
- Always wear eye protection when operating machine.
- Data indicates that operators, age 60 years and above, are involved in a large percentage of riding mower-related injuries. These operators should evaluate their ability to operate the riding mower safely enough to protect themselves and others from serious injury.
- Follow the manufacturer's recommendation for wheel weights or counterweights.
- Keep machine free of grass, leaves or other debris build-up which can touch hot exhaust / engine parts and burn. Do not allow the mower deck to plow leaves or other debris which can cause build-up to occur. Clean any oil or fuel spillage before operating or storing the machine. Allow machine to cool before storage.

### II. SLOPE OPERATION

Slopes are a major factor related to loss of control and tip-over accidents, which can result in severe injury or death. Operation on all slopes requires extra caution. If you cannot back up the slope or if you feel uneasy on it, do not mow it.

- Mow up and down slopes, not across.
- Watch for holes, ruts, bumps, rocks, or other hidden objects. Uneven terrain could overturn the machine. Tall grass can hide obstacles.
- Choose a low ground speed so that you will not have to stop or shift while on the slope.
- Do not mow on wet grass. Tires may lose traction. Always keep the machine in gear when going down slopes. Do not shift to neutral and coast downhill.
- Avoid starting, stopping, or turning on a slope. If the tires lose traction, disengage the blades and proceed slowly straight down the slope.
- Keep all movement on the slopes slow and gradual. Do not make sudden changes in speed or direction, which could cause the machine to roll over.
- Use extra care while operating machine with grass catchers or other attachments; they can affect the stability of the machine. Do no use on steep slopes.
- Do not try to stabilize the machine by putting your foot on the ground.
- Do not mow near drop-offs, ditches, or embankments. The machine could suddenly roll over if a wheel is over the edge or if the edge caves in.



# SAFETY RULES



## Safe Operation Practices for Ride-On Mowers

### III. CHILDREN

Tragic accidents can occur if the operator is not alert to the presence of children. Children are often attracted to the machine and the mowing activity. *Never* assume that children will remain where you last saw them.

- Keep children out of the mowing area and in the watchful care of a responsible adult other than the operator.
- Be alert and turn machine off if a child enters the area.
- Before and while backing, look behind and down for small children.
- Never carry children, even with the blades shut off. They may fall off and be seriously injured or interfere with safe machine operation. Children who have been given rides in the past may suddenly appear in the mowing area for another ride and be run over or backed over by the machine.
- Never allow children to operate the machine.
- Use extra care when approaching blind corners, shrubs, trees, or other objects that may block your view of a child.

### IV. TOWING

- Tow only with a machine that has a hitch designed for towing. Do not attach towed equipment except at the hitch point.
- Follow the manufacturer's recommendation for weight limits for towed equipment and towing on slopes.
- Never allow children or others in or on towed equipment.
- On slopes, the weight of the towed equipment may cause loss of traction and loss of control.
- Travel slowly and allow extra distance to stop.

### V. SERVICE

#### SAFE HANDLING OF GASOLINE

To avoid personal injury or property damage, use extreme care in handling gasoline. Gasoline is extremely flammable and the vapors are explosive.

- Extinguish all cigarettes, cigars, pipes, and other sources of ignition.
- Use only approved gasoline container.
- Never remove gas cap or add fuel with the engine running. Allow engine to cool before refueling.
- Never fuel the machine indoors.
- Never store the machine or fuel container where there is an open flame, spark, or pilot light such as on a water heater or other appliances.
- Never fill containers inside a vehicle or on a truck or trailer bed with plastic liner. Always place containers on the ground away from your vehicle when filling.
- Remove gas-powered equipment from the truck or trailer and refuel it on the ground. If this is not possible, then refuel such equipment with a portable container, rather than from a gasoline dispenser nozzle.
- Keep the nozzle in contact with the rim of the fuel tank or container opening at all times until fueling is complete. Do not use a nozzle lock-open device.
- If fuel is spilled on clothing, change clothing immediately.
- Never overfill fuel tank. Replace gas cap and tighten securely.

### GENERAL SERVICE

- Never operate machine in a closed area.
- Keep all nuts and bolts tight to be sure the equipment is in safe working condition.
- Never tamper with safety devices. Check their proper operation regularly.
- Keep machine free of grass, leaves, or other debris build-up. Clean oil or fuel spillage and remove any fuel-soaked debris. Allow machine to cool before storing.
- If you strike a foreign object, stop and inspect the machine. Repair, if necessary, before restarting.
- Never make any adjustments or repairs with the engine running.
- Check grass catcher components and the discharge guard frequently and replace with manufacturer's recommended parts, when necessary.
- Mower blades are sharp. Wrap the blade or wear gloves, and use extra caution when servicing them.
- Check brake operation frequently. Adjust and service as required.
- Maintain or replace safety and instruction labels, as necessary.



- Be sure the area is clear of bystanders before operating. Stop machine if anyone enters the area.
- Never carry passengers.
- Do not mow in reverse unless absolutely necessary. Always look down and behind before and while backing.
- Never carry children, even with the blades shut off. They may fall off and be seriously injured or interfere with safe machine operation. Children who have been given rides in the past may suddenly appear in the mowing area for another ride and be run over or backed over by the machine.
- Keep children out of the mowing area and in the watchful care of a responsible adult other than the operator.
- Be alert and turn machine off if a child enters the area.
- Before and while backing, look behind and down for small children.
- Mow up and down slopes (15° Max), not across.
- Choose a low ground speed so that you will not have to stop or shift while on the slope.
- Avoid starting, stopping, or turning on a slope. If the tires lose traction, disengage the blades and proceed slowly straight down the slope.
- If machine stops while going uphill, disengage blades, shift into reverse and back down slowly.
- Do not turn on slopes unless necessary, and then, turn slowly and gradually downhill, if possible.

## PRODUCT SPECIFICATIONS

Gasoline Capacity and type:	1.25 Gallons Unleaded Regular
Oil Type (API-SG-SL):	SAE 30 (above 32°F) SAE 5W-30 (below 32°F)
Oil Capacity:	3 Pints
Spark Plug: (Gap: .030")	Champion RC12YC
Ground Speed (MPH):	Forward: 1st 1.1 2nd 1.4 3rd 2.2 4th 3.3 5th 4.4 6th 4.9 Reverse: 1.4
Tire Pressure:	Front: 14 PSI Rear: 12 PSI
Charging System:	3 Amps Battery 5 Amps Headlights
Battery:	AMP/HR: 28 MIN. CCA: 230 Case Size: U1R
Blade Bolt Torque:	27-35 FT. LBS.

**CONGRATULATIONS** on your purchase of a new tractor. It has been designed, engineered and manufactured to give you the best possible dependability and performance.

Should you experience any problem you cannot easily remedy, please contact your nearest authorized service center/department. We have competent, well-trained technicians and the proper tools to service or repair this tractor.

Please read and retain this manual. The instructions will enable you to assemble and maintain your tractor properly. Always observe the "SAFETY RULES".

## CUSTOMER RESPONSIBILITIES

- Read and observe the safety rules.
- Follow a regular schedule in maintaining, caring for and using your tractor.
- Follow the instructions under "Maintenance" and "Storage" sections of this owner's manual.

**WARNING:** This tractor is equipped with an internal combustion engine and should not be used on or near any unimproved forest-covered, brush-covered or grass-covered land unless the engine's exhaust system is equipped with a spark arrester meeting applicable local or state laws (if any). If a spark arrester is used, it should be maintained in effective working order by the operator.

A spark arrester for the muffler is available through your nearest authorized service center/department (See REPAIR PARTS section of this manual).

## TABLE OF CONTENTS

SAFETY RULES .....	2-3
PRODUCT SPECIFICATIONS .....	4
CUSTOMER RESPONSIBILITIES .....	4
ASSEMBLY .....	6-8
OPERATION .....	9-13
MAINTENANCE SCHEDULE .....	14

MAINTENANCE .....	14-17
SERVICE AND ADJUSTMENTS .....	18-21
STORAGE .....	22
TROUBLESHOOTING .....	23-24
REPAIR PARTS .....	26-39

# UNASSEMBLED PARTS

## Steering Wheel

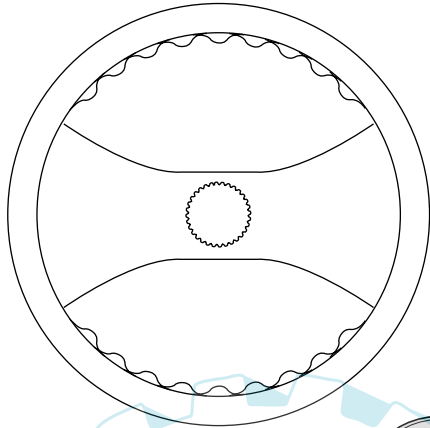

Steering Wheel Insert



Steering Extension Shaft

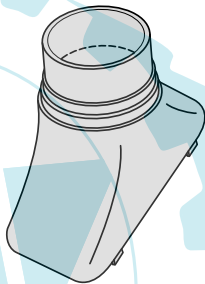

Steering Boot

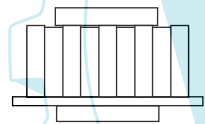

Steering Wheel Adapter

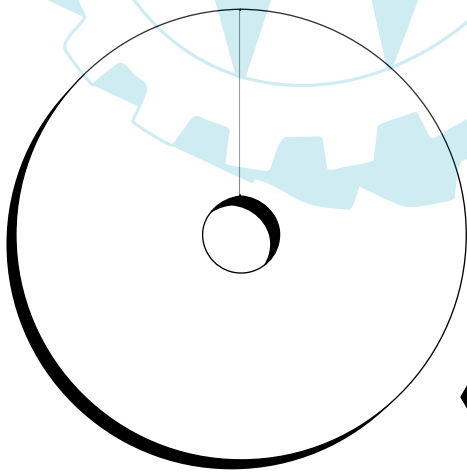

(1) Large Flat Washer

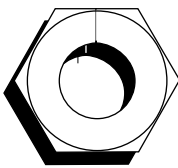

(1) Locknut 1/2-20

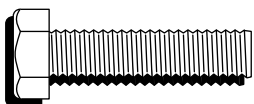

(1) Hex Bolt 1/4-28 x 1-1/4



(1) Locknut 1/4-28

## Seat

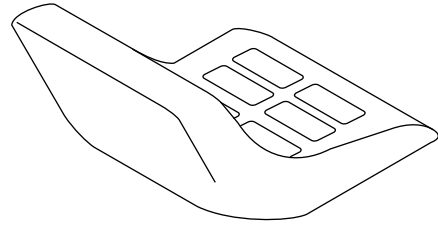

(1) Washer  
17/32 x 1-3/16 x 12 Gauge

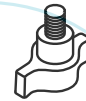

(1) Knob



(1) Oil Drain Tube  
For Future Use

## Keys

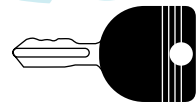

(2) Keys

## Slope Sheet

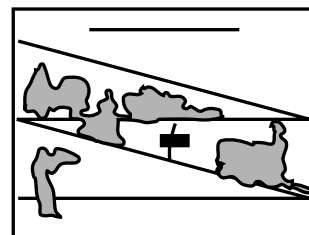



# ASSEMBLY

Your new tractor has been assembled at the factory with exception of those parts left unassembled for shipping purposes. To ensure safe and proper operation of your tractor all parts and hardware you assemble must be tightened securely. Use the correct tools as necessary to insure proper tightness.

## TOOLS REQUIRED FOR ASSEMBLY

A socket wrench set will make assembly easier. Standard wrench sizes are listed.

- |                   |                     |
|-------------------|---------------------|
| (2) 1/2" wrenches | Pliers              |
| (1) 9/16" wrench  | Tire pressure gauge |
| Utility knife     |                     |

When right or left hand is mentioned in this manual, it means when you are in the operating position (seated behind the steering wheel).

## TO REMOVE TRACTOR FROM CARTON

### UNPACK CARTON

- Remove all accessible loose parts and parts cartons from carton.
- Cut along dotted lines on all four panels of carton. Remove end panels and lay side panels flat.
- Check for any additional loose parts or cartons and remove.

## BEFORE REMOVING TRACTOR FROM SKID

### ATTACH STEERING WHEEL (See Fig. 1)

#### ASSEMBLE EXTENSION SHAFT AND BOOT

- Slide extension shaft onto lower steering shaft. Align mounting holes in extension and lower shafts and install 1/4 hex bolt and locknut. Tighten securely.

**IMPORTANT:** TIGHTEN BOLT AND NUT SECURELY TO 10-12 FT. LBS TORQUE.

- Place tabs of steering boot over tab slots in dash and push down to secure.

#### INSTALL STEERING WHEEL

- Position front wheels of the tractor so they are pointing straight forward.
- Remove steering wheel adapter from steering wheel and slide adapter onto steering shaft extension.
- Position steering wheel so cross bars are horizontal (left to right) and slide inside boot and onto adapter.
- Assemble large flat washer, 1/2 hex nut and tighten securely.
- Snap steering wheel insert into center of steering wheel.
- Remove protective materials from tractor hood and grill.

**IMPORTANT:** CHECK FOR AND REMOVE ANY STAPLES IN SKID THAT MAY PUNCTURE TIRES WHERE TRACTOR IS TO ROLL OFF SKID.

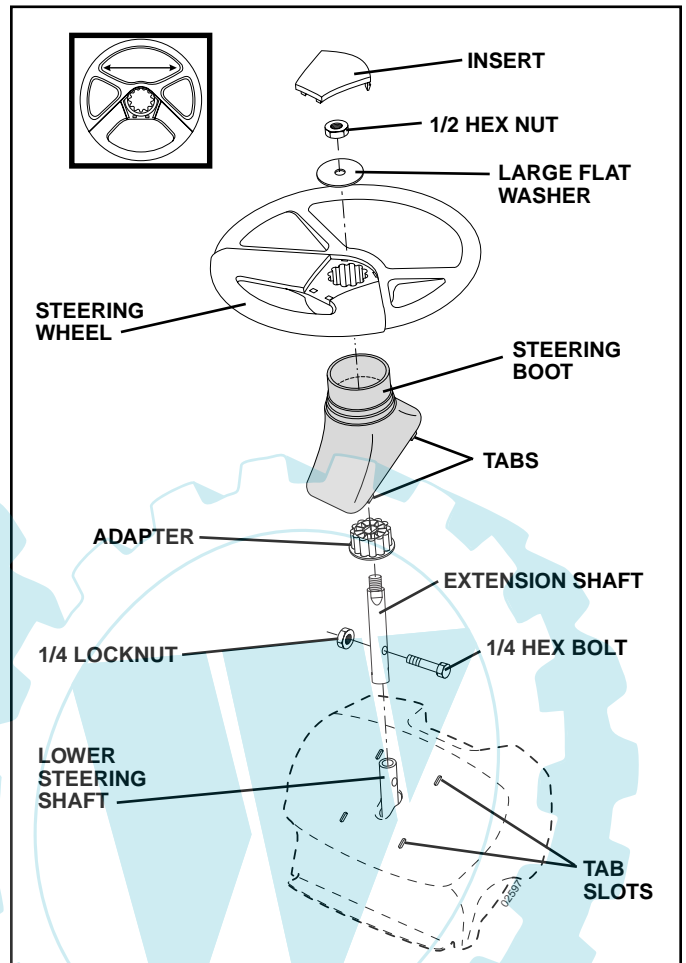

FIG. 1

### INSTALL SEAT (See Fig. 2)

Adjust seat before tightening adjustment knob.

- Remove adjustment knob and flat washer securing seat to cardboard packing and set aside for assembly of seat to tractor.
- Pivot seat upward and remove from the cardboard packing. Remove the cardboard packing and discard.
- Place seat on seat pan so head of shoulder bolts are positioned over the large slotted holes in pan.
- Push down on seat to engage shoulder bolts in slots and pull seat towards rear of tractor.
- Pivot seat and pan forward and assemble adjustment knob and flat washer loosely. Do not tighten.
- Lower seat into operating position and sit in seat.
- Slide seat until a comfortable position is reached which allows you to press clutch/brake pedal all the way down.
- Get off seat without moving its adjusted position.
- Raise seat and tighten adjustment knob securely.

# ASSEMBLY

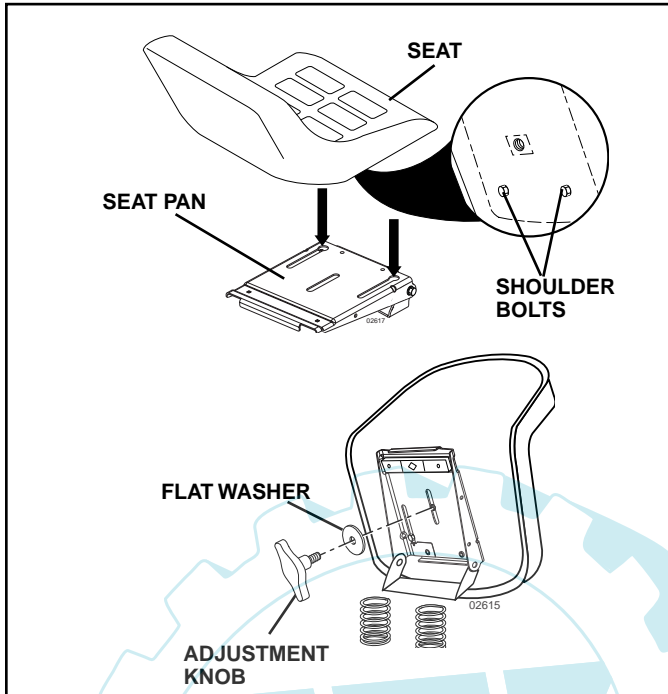

FIG. 2

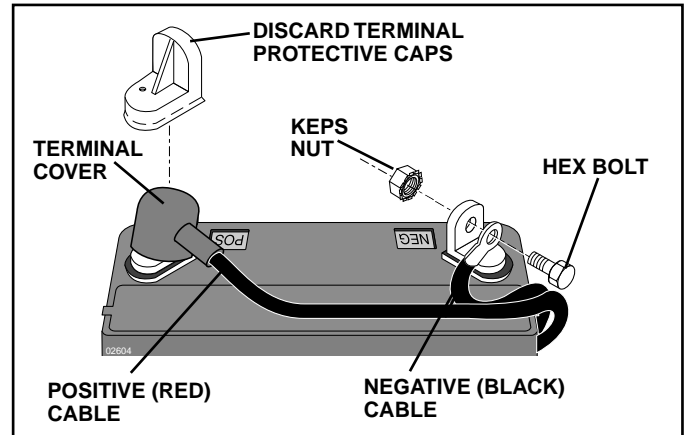

FIG. 3

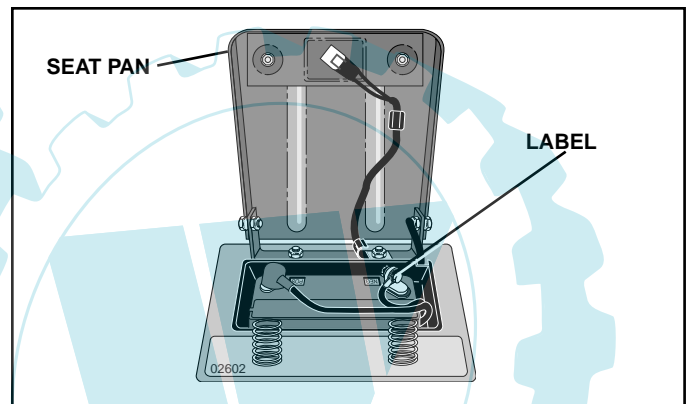

FIG. 4

## CONNECT BATTERY (See Figs. 3 and 4)



**CAUTION:** Do not short battery terminals by allowing a wrench or any other object to contact both terminals at the same time. Before connecting battery, remove metal bracelets, wristwatch bands, rings, etc.

**Positive terminal must be connected first to prevent sparking from accidental grounding.**

- Lift seat pan to raised position.
- Remove terminal protective caps and discard.
- If this battery is put into service after month and year indicated on label (label located between terminals) charge battery for minimum of one hour at 6-10 amps. (See "BATTERY" in the Maintenance section of this manual for charging instructions).
- First connect RED battery cable to positive (+) terminal with hex bolt and keps nut as shown. Tighten securely. Slide terminal cover over terminal.
- Connect BLACK grounding cable to negative (-) terminal with remaining hex bolt and keps nut. Tighten securely.

# ASSEMBLY

**NOTE:** You may now roll or drive your tractor off the skid. Follow the appropriate instruction below to remove the tractor from the skid.

## TO ROLL TRACTOR OFF SKID (See Operation section for location and function of controls)

- Press lift lever plunger and raise attachment lift lever to its highest position.
- Release parking brake by depressing clutch/brake pedal.
- Place gearshift lever in neutral (N) position.
- Roll tractor forward off skid.
- Remove banding holding deflector shield up against tractor.

## TO DRIVE TRACTOR OFF SKID (See Operation section for location and function of controls)

**⚠WARNING:** Before starting, read, understand and follow all instructions in the Operation section of this manual. Be sure tractor is in a well-ventilated area. Be sure the area in front of tractor is clear of other people and objects.

- Be sure all the above assembly steps have been completed.
- Check engine oil level and fill fuel tank with gasoline.
- Sit on seat in operating position, depress clutch/brake pedal and set the parking brake.
- Place gear shift lever in neutral (N) position.
- Press lift lever plunger and raise attachment lift lever to its highest position.
- Start the engine. After engine has started, move throttle control to idle position.
- Depress clutch/brake pedal into full "BRAKE" position and hold. Move gearshift lever to 1st gear.
- Slowly release clutch/brake pedal and slowly drive tractor off skid.
- Apply brake to stop tractor, set parking brake and place gearshift lever in neutral position.
- Turn ignition key to "OFF" position.

Continue with the instructions that follow.

## CHECK TIRE PRESSURE

The tires on your tractor were overinflated at the factory for shipping purposes. Correct tire pressure is important for best cutting performance.

- Reduce tire pressure to PSI shown in "PRODUCT SPECIFICATIONS" section of this manual.

## CHECK DECK LEVELNESS

For best cutting results, mower housing should be properly leveled. See "TO LEVEL MOWER HOUSING" in the Service and Adjustments section of this manual.

## CHECK FOR PROPER POSITION OF ALL BELTS

See the figures that are shown for replacing motion and mower blade drive belts in the Service and Adjustments section of this manual. Verify that the belts are routed correctly.

## CHECK BRAKE SYSTEM

After you learn how to operate your tractor, check to see that the brake is properly adjusted. See "TO ADJUST BRAKE" in the Service and Adjustments section of this manual.

## ✓ CHECKLIST

*BEFORE YOU OPERATE AND ENJOY YOUR NEW TRACTOR, WE WISH TO ASSURE THAT YOU RECEIVE THE BEST PERFORMANCE AND SATISFACTION FROM THIS QUALITY PRODUCT.*

*PLEASE REVIEW THE FOLLOWING CHECKLIST:*

- ✓ All assembly instructions have been completed.
- ✓ No remaining loose parts in carton.
- ✓ Battery is properly prepared and charged. (Minimum 1 hour at 6 amps).
- ✓ Seat is adjusted comfortably and tightened securely.
- ✓ All tires are properly inflated. (For shipping purposes, the tires were overinflated at the factory).
- ✓ Be sure mower deck is properly leveled side-to-side/front-to-rear for best cutting results. (Tires must be properly inflated for leveling).
- ✓ Check mower and drive belts. Be sure they are routed properly around pulleys and inside all belt keepers.
- ✓ Check wiring. See that all connections are still secure and wires are properly clamped.































*WHILE LEARNING HOW TO USE YOUR TRACTOR, PAY EXTRA ATTENTION TO THE FOLLOWING IMPORTANT ITEMS:*

- ✓ Engine oil is at proper level.
- ✓ Fuel tank is filled with fresh, clean, regular unleaded gasoline.
- ✓ Become familiar with all controls - their location and function. Operate them before you start the engine.
- ✓ Be sure brake system is in safe operating condition.







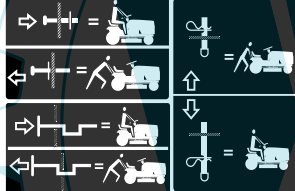

# OPERATION

These symbols may appear on your tractor or in literature supplied with the product. Learn and understand their meaning.

 REVERSE	 NEUTRAL	 HIGH	 LOW	 CHOKE	 FAST	 SLOW	 IGNITION
 ENGINE OFF	 LIGHTS ON	 ENGINE ON	 ENGINE START	 PARKING BRAKE	 PARKING BRAKE LOCKED	 PARKING BRAKE UNLOCKED	
 OVER TEMP LIGHT	 FUEL	 OIL PRESSURE	 BATTERY	 REVERSE	 FORWARD	 MOWER HEIGHT	 MOWER LIFT
 ATTACHMENT CLUTCH ENGAGED	 ATTACHMENT CLUTCH DISENGAGED	 DANGER, KEEP HANDS AND FEET AWAY		     KEEP AREA CLEAR (SEE SAFETY RULES SECTION)      SLOPE HAZARDS			

 FREE WHEEL (Automatic Models only)	 <b>DANGER</b> indicates a hazard which, if not avoided, will result in death or serious injury.
 <b>WARNING</b> indicates a hazard which, if not avoided, could result in death or serious injury.	 <b>CAUTION</b> indicates a hazard which, if not avoided, might result in minor or moderate injury.
	<b>CAUTION</b> when used <b>without</b> the alert symbol, indicates a situation that <b>could result in damage to the tractor and/or engine.</b>
 <b>HOT SURFACES</b> indicates a hazard which, if not avoided, could result in death, serious injury and/or property damage.	 <b>FIRE</b> indicates a hazard which, if not avoided, could result in death, serious injury and/or property damage.

Failure to follow instructions could result in serious injury or death. The safety alert symbol is used to identify safety information about hazards which can result in death, serious injury and/or property damage.

# OPERATION

## KNOW YOUR TRACTOR

### READ THIS OWNER'S MANUAL AND SAFETY RULES BEFORE OPERATING YOUR TRACTOR

Compare the illustrations with your tractor to familiarize yourself with the locations of various controls and adjustments. Save this manual for future reference.

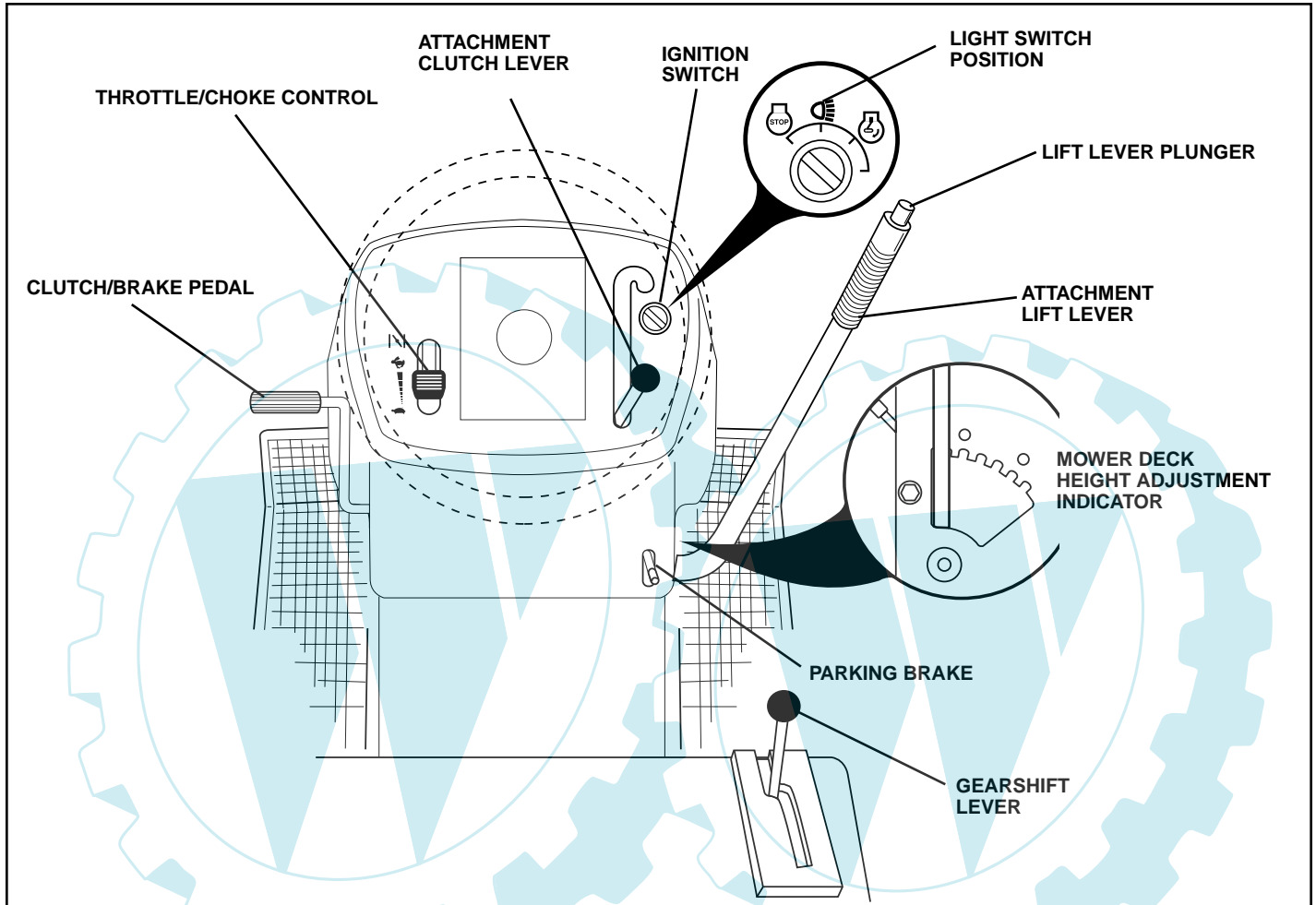

FIG. 5

Our tractors conform to the safety standards of the American National Standards Institute.

**ATTACHMENT CLUTCH LEVER** - Used to engage the mower blades, or other attachments mounted to your tractor.

**ATTACHMENT LIFT LEVER** - Used to raise, lower, and adjust the mower deck or other attachments mounted to your tractor.

**CLUTCH/BRAKE PEDAL** - Used for declutching and braking the tractor and starting the engine.

**GEARSHIFT LEVER** - Selects the speed and direction of tractor.

**IGNITION SWITCH** - Used for starting and stopping the engine.

**LIFT LEVER PLUNGER** - Used to release attachment lift lever when changing its position.

**LIGHT SWITCH POSITION** - Turns headlights on and off.

**PARKING BRAKE** - Locks clutch/brake pedal into the brake position.

**THROTTLE/CHOKE CONTROL** - Used for starting and controlling engine speed.

# OPERATION



The operation of any tractor can result in foreign objects thrown into the eyes, which can result in severe eye damage. Always wear safety glasses or eye shields while operating your tractor or performing any adjustments or repairs. We recommend a wide vision safety mask over spectacles or standard safety glasses.

## HOW TO USE YOUR TRACTOR

### TO SET PARKING BRAKE (See Fig. 6)

Your tractor is equipped with an operator presence sensing switch. When engine is running, any attempt by the operator to leave the seat without first setting the parking brake will shut off the engine.

- Depress clutch/brake pedal into full "BRAKE" position and hold.
- Place parking brake lever in "ENGAGED" position and release pressure from clutch/brake pedal. Pedal should remain in "BRAKE" position. Make sure parking brake will hold tractor secure.

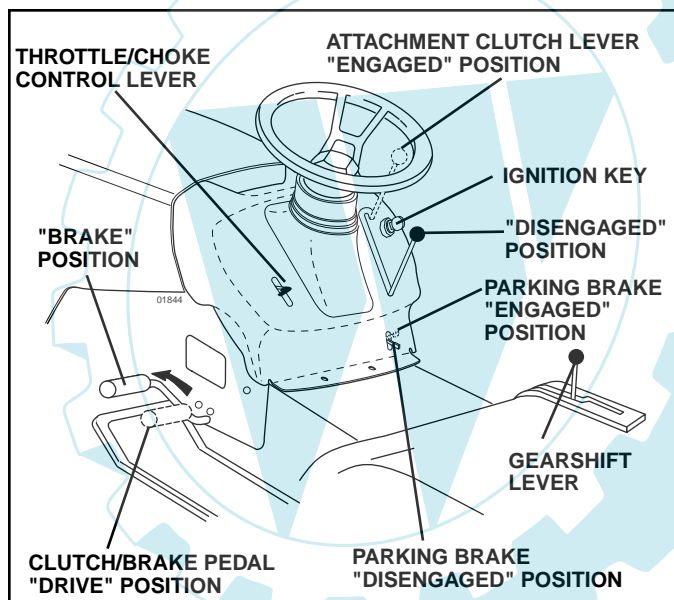

FIG. 6

### STOPPING (See Fig. 6)

MOWER BLADES -

- To stop mower blades, move attachment clutch lever to "DISENGAGED" position.

GROUND DRIVE -

- To stop ground drive, depress clutch/brake pedal into full "BRAKE" position.
- Move gearshift lever to neutral (N) position.

ENGINE -

- Move throttle control between half and full speed (fast) position.

**NOTE:** Failure to move throttle control between half and full speed (fast) position, before stopping may cause engine to "backfire".

- Turn ignition key to "STOP" position and remove key. Always remove key when leaving tractor to prevent unauthorized use.
- Never use choke to stop engine.

**IMPORTANT:** LEAVING THE IGNITION SWITCH IN ANY POSITION OTHER THAN "STOP" WILL CAUSE THE BATTERY TO BE DISCHARGED, (DEAD).

**NOTE:** Under certain conditions when tractor is standing idle with the engine running, hot engine exhaust gases may cause "browning" of grass. To eliminate this possibility, always stop engine when stopping tractor on grass areas.



**CAUTION:** Always stop tractor completely, as described above, before leaving the operator's position; to empty grass catcher, etc.

### TO USE THROTTLE CONTROL (See Fig. 6)

Always operate engine at full throttle.

- Operating engine at less than full throttle reduces the battery charging rate.
- Full throttle offers the best bagging and mower performance.

### TO MOVE FORWARD AND BACKWARD (See Fig. 6)

The direction and speed of movement is controlled by the gearshift lever.

- Start tractor with clutch/brake pedal depressed and gearshift lever in neutral (N) position.
- Move gearshift lever to desired position.
- Slowly release clutch/brake pedal to start movement.

**IMPORTANT:** BRING TRACTOR TO A COMPLETE STOP BEFORE SHIFTING OR CHANGING GEARS. FAILURE TO DO SO WILL SHORTEN THE USEFUL LIFE OF YOUR TRANSAXLE.

### TO ADJUST MOWER CUTTING HEIGHT (See Fig. 6)

The position of the attachment lift lever determines the cutting height.

- Grasp lift lever.
- Press plunger with thumb and move lever to desired position.

The cutting height range is approximately 1-1/2 to 4". The heights are measured from the ground to the blade tip with the engine not running. These heights are approximate and may vary depending upon soil conditions, height of grass and types of grass being mowed.

- The average lawn should be cut to approximately 2-1/2 inches during the cool season and to over 3 inches during hot months. For healthier and better looking lawns, mow often and after moderate growth.
- For best cutting performance, grass over 6 inches in height should be mowed twice. Make the first cut relatively high; the second to desired height.

# OPERATION

## TO OPERATE MOWER (See Fig. 7)

Your tractor is equipped with an operator presence sensing switch. Any attempt by the operator to leave the seat with the engine running and the attachment clutch engaged will shut off the engine. You must remain fully and centrally positioned in the seat to prevent the engine from hesitating or cutting off when operating your equipment on rough, rolling terrain or hills.

- Select desired height of cut.
- Start mower blades by engaging attachment clutch control.
- TO STOP MOWER BLADES - disengage attachment clutch control.



**CAUTION:** Do not operate the mower without either the entire grass catcher, on mowers so equipped, or the deflector shield in place.

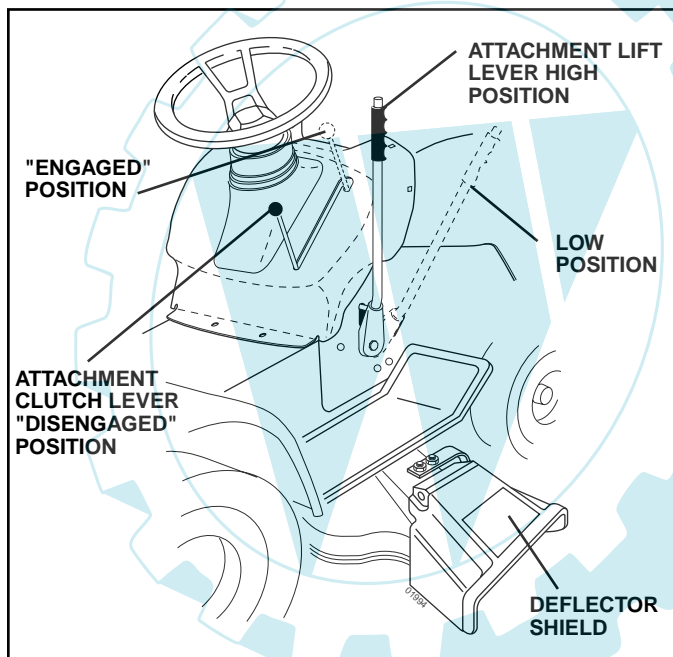

FIG. 7

## TO OPERATE ON HILLS



**WARNING:** Do not drive up or down hills with slopes greater than 15° and do not drive across any slope.

- Choose the slowest speed before starting up or down hills.
- Avoid stopping or changing speed on hills.
- If slowing is necessary, move throttle control lever to slower position.
- If stopping is absolutely necessary, push clutch/brake pedal quickly to brake position and engage parking brake.
- Move gearshift lever to 1st gear. Be sure you have allowed room for tractor to roll slightly as you restart movement.

- To restart movement, slowly release parking brake and clutch/brake pedal.
- Make all turns slowly.

## TO TRANSPORT

- Raise attachment lift to highest position with attachment lift control.
- When pushing or towing your tractor, be sure gearshift lever is in neutral (N) position.
- Do not push or tow tractor at more than five (5) MPH.

**NOTE:** To protect hood from damage when transporting your tractor on a truck or a trailer, be sure hood is closed and secured to tractor. Use an appropriate means of tying hood to tractor (rope, cord, etc.).

## TOWING CARTS AND OTHER ATTACHMENTS

Tow only the attachments that are recommended by and comply with specifications of the manufacturer of your tractor. Use common sense when towing. Too heavy of a load, while on a slope, is dangerous. Tires can lose traction with the ground and cause you to lose control of your tractor.

## BEFORE STARTING THE ENGINE

### CHECK ENGINE OIL LEVEL

The engine in your tractor has been shipped, from the factory, already filled with summer weight oil.

- Check engine oil with tractor on level ground.
- Remove oil fill cap/dipstick and wipe clean, reinsert the dipstick and screw cap tight, wait for a few seconds, remove and read oil level. If necessary, add oil until "FULL" mark on dipstick is reached. Do not overfill.
- For cold weather operation you should change oil for easier starting (See "OIL VISCOSITY CHART" in the Maintenance section of this manual).
- To change engine oil, see the Maintenance section in this manual.

### ADD GASOLINE

- Fill fuel tank to bottom of filler neck. Do not overfill. Use fresh, clean, regular unleaded gasoline with a minimum of 87 octane. (Use of leaded gasoline will increase carbon and lead oxide deposits and reduce valve life). Do not mix oil with gasoline. Purchase fuel in quantities that can be used within 30 days to assure fuel freshness.



**CAUTION:** Wipe off any spilled oil or fuel. Do not store, spill or use gasoline near an open flame.

**IMPORTANT:** WHEN OPERATING IN TEMPERATURES BELOW 32°F (0°C), USE FRESH, CLEAN WINTER GRADE GASOLINE TO HELP INSURE GOOD COLD WEATHER STARTING.



# OPERATION

**CAUTION:** Alcohol blended fuels (called gasohol or using ethanol or methanol) can attract moisture which leads to separation and formation of acids during storage. Acidic gas can damage the fuel system of an engine while in storage. To avoid engine problems, the fuel system should be emptied before storage of 30 days or longer. Drain the gas tank, start the engine and let it run until the fuel lines and carburetor are empty. Use fresh fuel next season. See Storage Instructions for additional information. Never use engine or carburetor cleaner products in the fuel tank or permanent damage may occur.

## TO START ENGINE (See Fig. 5)

When starting the engine for the first time or if the engine has run out of fuel, it will take extra cranking time to move fuel from the tank to the engine.

- Sit on seat in operating position, depress clutch/brake pedal and set parking brake.
- Place gear shift lever in neutral (N) position.
- Move attachment clutch to "DISENGAGED" position.
- Move throttle control to choke position.

**NOTE:** Before starting, read the warm and cold starting procedures below.

- Insert key into ignition and turn key clockwise to "START" position and release key as soon as engine starts. Do not run starter continuously for more than fifteen seconds per minute. If the engine does not start after several attempts, move throttle control to fast position, wait a few minutes and try again. If engine still does not start, move the throttle control back to the choke position and retry.

### WARM WEATHER STARTING (50° F and above)

- When engine starts, move the throttle control to the fast position.
- The attachments and ground drive can now be used. If the engine does not accept the load, restart the engine and allow it to warm up for one minute using the choke as described above.

### COLD WEATHER STARTING ( 50° F and below)

- When engine starts, allow engine to run with the throttle control in the choke position until the engine runs roughly, then move throttle control to fast position. This may require an engine warm-up period from several seconds to several minutes, depending on the temperature.
- The attachments can also be used during the engine warm-up period.

**NOTE:** If at a high altitude (above 3000 feet) or in cold temperatures (below 32 F) the carburetor fuel mixture may need to be adjusted for best engine performance. See "TO ADJUST CARBURETOR" in the Service and Adjustments section of this manual.

## MOWING TIPS

- Mower should be properly leveled for best mowing performance. See "TO LEVEL MOWER HOUSING" in the Service and Adjustments section of this manual.
- The left hand side of mower should be used for trimming.
- Drive so that clippings are discharged onto the area that has been cut. Have the cut area to the right of the machine. This will result in a more even distribution of clippings and more uniform cutting.
- When mowing large areas, start by turning to the right so that clippings will discharge away from shrubs, fences, driveways, etc. After one or two rounds, mow in the opposite direction making left hand turns until finished (See Fig. 8).

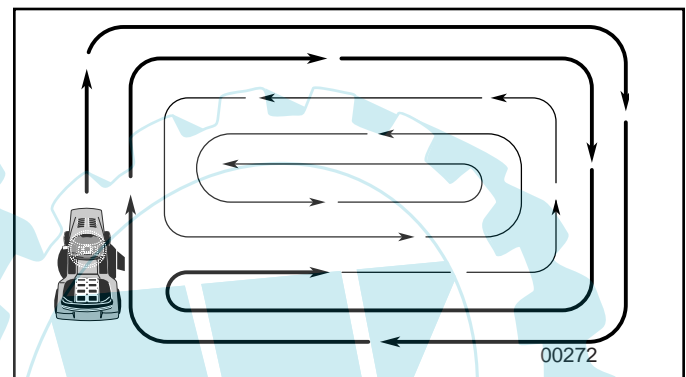

FIG. 8

- If grass is extremely tall, it should be mowed twice to reduce load and possible fire hazard from dried clippings. Make first cut relatively high; the second to the desired height.
- Do not mow grass when it is wet. Wet grass will plug mower and leave undesirable clumps. Allow grass to dry before mowing.
- **Always operate engine at full throttle when mowing** to assure better mowing performance and proper discharge of material. Regulate ground speed by selecting a low enough gear to give the mower cutting performance as well as the quality of cut desired.
- When operating attachments, select a ground speed that will suit the terrain and give best performance of the attachment being used.



# MAINTENANCE

MAINTENANCE SCHEDULE		SERVICE DATES						
		BEFORE EACH USE	EVERY 8 HOURS	EVERY 25 HOURS	EVERY 50 HOURS	EVERY 100 HOURS	EVERY SEASON	BEFORE STORAGE
TRACTOR	Check Brake Operation	✓	✓					
	Check Tire Pressure	✓	✓					
	Check Operator Presence and Interlock Systems	✓						
	Check for Loose Fasteners	✓			✓ <sup>5</sup>	✓		
	Sharpen/Replace Mower Blades			✓ <sup>3</sup>				
	Lubrication Chart			✓		✓		
	Check Battery Level			✓ <sup>4</sup>				
	Clean Battery and Terminals			✓		✓		
	Check Transaxle Cooling			✓				
	Check V-Belts				✓			
	ENGINE	Check Engine Oil Level	✓	✓				
Change Engine Oil (with oil filter)					✓ <sup>1,2</sup>		✓	
Change Engine Oil (without oil filter)				✓ <sup>1,2</sup>			✓	
Clean Air Filter				✓ <sup>2</sup>				
Clean Air Screen				✓ <sup>2</sup>				
Inspect Muffler/Spark Arrester					✓			
Replace Oil Filter (If equipped)						✓ <sup>1,2</sup>		
Clean Engine Cooling Fins						✓ <sup>2</sup>		
Replace Spark Plug						✓	✓	
Replace Air Filter Paper Cartridge						✓ <sup>2</sup>		
Replace Fuel Filter						✓		

1 - Change more often when operating under a heavy load or in high ambient temperatures.  
 2 - Service more often when operating in dirty or dusty conditions.

3 - Replace blades more often when mowing in sandy soil.  
 4 - Not required if equipped with maintenance-free battery.  
 5 - Tighten front axle pivot bolt to 35 ft.-lbs. maximum. Do not overtighten.

## GENERAL RECOMMENDATIONS

The warranty on this tractor does not cover items that have been subjected to operator abuse or negligence. To receive full value from the warranty, operator must maintain tractor as instructed in this manual.

Some adjustments will need to be made periodically to properly maintain your tractor.

At least once a season, check to see if you should make any of the adjustments described in the Service and Adjustments section of this manual.

- At least once a year you should replace the spark plug, clean or replace air filter, and check blades and belts for wear. A new spark plug and clean air filter assure proper air-fuel mixture and help your engine run better and last longer.

## BEFORE EACH USE

- Check engine oil level.
- Check brake operation.
- Check tire pressure.
- Check operator presence and interlock systems for proper operation.
- Check for loose fasteners.

## LUBRICATION CHART

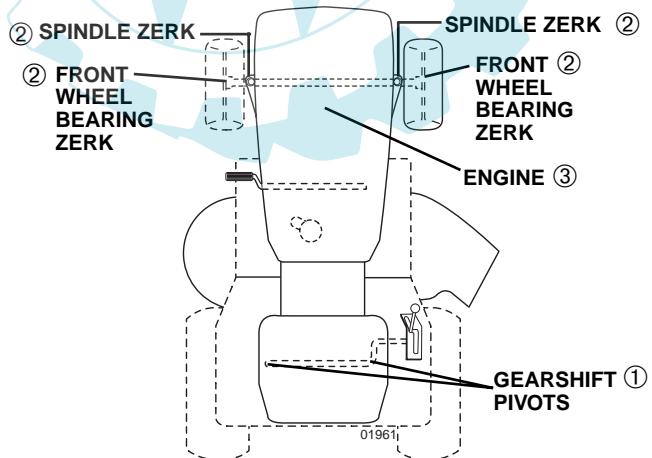

- ① SAE 30 or 10w30 motor oil
- ② General Purpose Grease
- ③ Refer to Maintenance "ENGINE" Section

**IMPORTANT:** DO NOT OIL OR GREASE THE PIVOT POINTS WHICH HAVE SPECIAL NYLON BEARINGS. VISCOUS LUBRICANTS WILL ATTRACT DUST AND DIRT THAT WILL SHORTEN THE LIFE OF THE SELF-LUBRICATING BEARINGS. IF YOU FEEL THEY MUST BE LUBRICATED, USE ONLY A DRY, POWDERED GRAPHITE TYPE LUBRICANT SPARINGLY.

# MAINTENANCE

## TRACTOR

Always observe safety rules when performing any maintenance.

## BRAKE OPERATION

If tractor requires more than five (5) feet to stop at highest speed in highest gear on a level, dry concrete or paved surface, then brake must be checked and adjusted. (See "TO ADJUST BRAKE" in the Service and Adjustments section of this manual).

## TIRES

- Maintain proper air pressure in all tires (See "PRODUCT SPECIFICATIONS" section of this manual).
- Keep tires free of gasoline, oil, or insect control chemicals which can harm rubber.
- Avoid stumps, stones, deep ruts, sharp objects and other hazards that may cause tire damage.

**NOTE:** To seal tire punctures and prevent flat tires due to slow leaks, tire sealant may be purchased from your local parts dealer. Tire sealant also prevents tire dry rot and corrosion.

## OPERATOR PRESENCE SYSTEM

Be sure operator presence and interlock systems are working properly. If your tractor does not function as described, repair the problem immediately.

- The engine should not start unless the clutch/brake pedal is fully depressed and attachment clutch control is in the disengaged position.
- When the engine is running, any attempt by the operator to leave the seat without first setting the parking brake should shut off the engine.
- When the engine is running and the attachment clutch is engaged, any attempt by the operator to leave the seat should shut off the engine.
- The attachment clutch should never operate unless the operator is in the seat.

## BLADE CARE

For best results mower blades must be kept sharp. Replace bent or damaged blades.

## BLADE REMOVAL (See Fig. 9)

- Raise mower to highest position to allow access to blades.
- Remove blade bolt, lock washer and flat washer securing blade.
- Install new or resharpened blade with trailing edge up towards deck as shown.

**IMPORTANT:** TO ENSURE PROPER ASSEMBLY, CENTER HOLE IN BLADE MUST ALIGN WITH STAR ON MANDREL ASSEMBLY.

- Reassemble blade bolt, lock washer and flat washer in exact order as shown.
- Tighten blade bolt securely (27-35 Ft. Lbs. torque).

**IMPORTANT:** BLADE BOLT IS HEAT TREATED. IF BOLT NEEDS REPLACING, REPLACE ONLY WITH APPROVE BOLT SHOWN IN THE REPAIR PARTS.

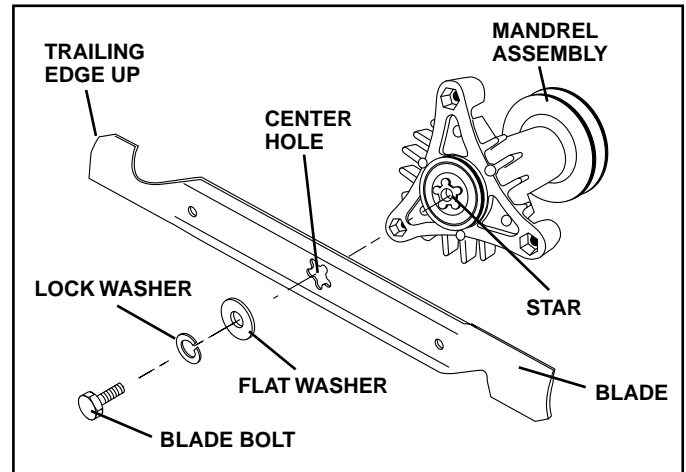

FIG. 9

## TO SHARPEN BLADE (See Fig. 10)

**NOTE:** We do not recommend sharpening blade - but if you do, be sure the blade is balanced.

Care should be taken to keep the blade balanced. An unbalanced blade will cause excessive vibration and eventual damage to mower and engine.

- The blade can be sharpened with a file or on a grinding wheel. Do not attempt to sharpen while on the mower.
- To check blade balance, you will need a 5/8" diameter steel bolt, pin, or a cone balancer. (When using a cone balancer, follow the instructions supplied with balancer.)

**NOTE:** Do not use a nail for balancing blade. The lobes of the center hole may appear to be centered, but are not.

- Slide blade on to an unthreaded portion of the steel bolt or pin and hold the bolt or pin parallel with the ground. If blade is balanced, it should remain in a horizontal position. If either end of the blade moves downward, sharpen the heavy end until the blade is balanced.

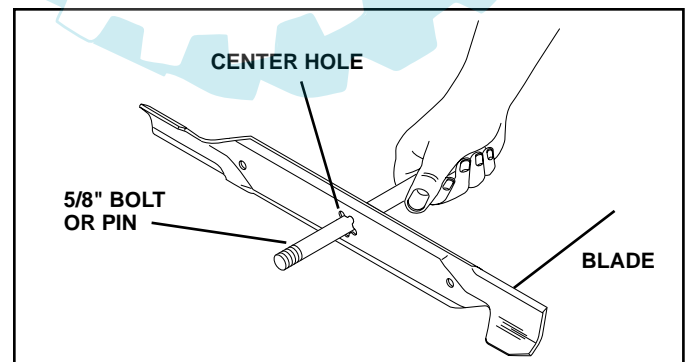

FIG. 10

# MAINTENANCE

## BATTERY

Your tractor has a battery charging system which is sufficient for normal use. However, periodic charging of the battery with an automotive charger will extend its life.

- Keep battery and terminals clean.
- Keep battery bolts tight.
- Keep small vent holes open.
- Recharge at 6-10 amperes for 1 hour.

**NOTE:** The original equipment battery on your tractor is maintenance free. Do not attempt to open or remove caps or covers. Adding or checking level of electrolyte is not necessary.

### TO CLEAN BATTERY AND TERMINALS

Corrosion and dirt on the battery and terminals can cause the battery to "leak" power.

- Disconnect **BLACK** battery cable first then **RED** battery cable and remove battery from tractor.
- Rinse the battery with plain water and dry.
- Clean terminals and battery cable ends with wire brush until bright.
- Coat terminals with grease or petroleum jelly.
- Reinstall battery (See "CONNECT BATTERY" in the Assembly section of this manual).

## V-BELTS

Check V-belts for deterioration and wear after 100 hours of operation and replace if necessary. The belts are not adjustable. Replace belts if they begin to slip from wear.

## TRANSAXLE COOLING

Keep transaxle free from build-up of dirt and chaff which can restrict cooling.

## ENGINE

### LUBRICATION

Only use high quality detergent oil rated with API service classification SG-SL. Select the oil's SAE viscosity grade according to your expected operating temperature.

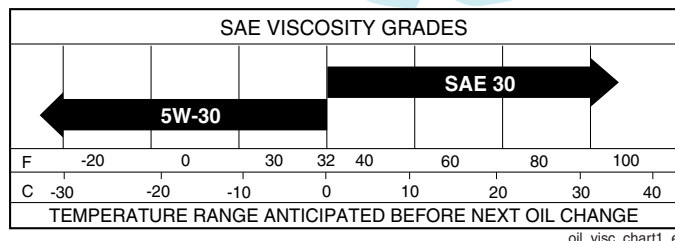

FIG. 11

**NOTE:** Although multi-viscosity oils (5W30, 10W30 etc.) improve starting in cold weather, they will result in increased oil consumption when used above 32°F. Check your engine oil level more frequently to avoid possible engine damage from running low on oil.

Change the oil after every 25 hours of operation or at least once a year if the tractor is not used for 25 hours in one year.

Check the crankcase oil level before starting the engine and after each eight (8) hours of operation. Tighten oil fill cap/dipstick securely each time you check the oil level.

### TO CHANGE ENGINE OIL (See Figs. 11 and 12)

Determine temperature range expected before oil change. All oil must meet API service classification SG-SL.

- Be sure tractor is on level surface.
- Oil will drain more freely when warm.
- Catch oil in a suitable container.
- Remove oil fill cap/dipstick. Be careful not to allow dirt to enter the engine when changing oil.
- Remove yellow cap from end of drain valve and install the drain tube onto the fitting.

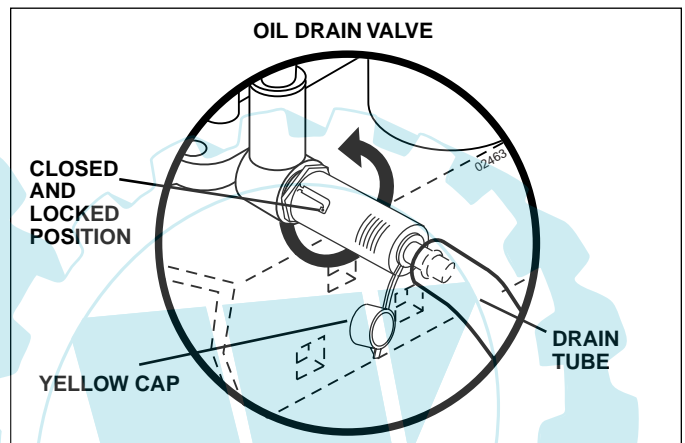

FIG. 12

- Unlock drain valve by pushing inward and turning counterclockwise.
- To open, pull out on the drain valve.
- After oil has drained completely, close and lock the drain valve by pushing inward and turning clockwise until the pin is in the locked position as shown.
- Remove the drain tube and replace the cap onto to the bottom fitting of the drain valve.
- Refill engine with oil through oil fill dipstick tube. Pour slowly. Do not overfill. For approximate capacity see "PRODUCT SPECIFICATIONS" section of this manual.
- Use gauge on oil fill cap/dipstick for checking level. Be sure dipstick cap is tightened securely for accurate reading. Keep oil at "FULL" line on dipstick. Tighten cap onto the tube securely when finished.

## CLEAN AIR SCREEN

Air screen must be kept free of dirt and chaff to prevent engine damage from overheating. Clean with a wire brush or compressed air to remove dirt and stubborn dried gum fibers.

## AIR FILTER

Your engine will not run properly using a dirty air filter. Service air cleaner more often under dusty conditions. See Engine Manual.

# MAINTENANCE

## CLEAN AIR INTAKE/COOLING AREAS

To insure proper cooling, make sure the grass screen, cooling fins, and other external surfaces of the engine are kept clean at all times.

Every 100 hours of operation (more often under extremely dusty, dirty conditions), remove the blower housing and other cooling shrouds. Clean the cooling fins and external surfaces as necessary. Make sure the cooling shrouds are reinstalled.

**NOTE:** Operating the engine with a blocked grass screen, dirty or plugged cooling fins, and/or cooling shrouds removed will cause engine damage due to overheating. See Engine Manual.

## MUFFLER

Inspect and replace corroded muffler and spark arrester (if equipped) as it could create a fire hazard and/or damage.

## SPARK PLUGS

Replace spark plugs at the beginning of each mowing season or after every 100 hours of operation, whichever occurs first. Spark plug type and gap setting are shown in "PRODUCT SPECIFICATIONS" section of this manual.

## IN-LINE FUEL FILTER (See Fig. 13)

The fuel filter should be replaced once each season. If fuel filter becomes clogged, obstructing fuel flow to carburetor, replacement is required.

- With engine cool, remove filter and plug fuel line sections.
- Place new fuel filter in position in fuel line with arrow pointing towards carburetor.
- Be sure there are no fuel line leaks and clamps are properly positioned.
- Immediately wipe up any spilled gasoline.

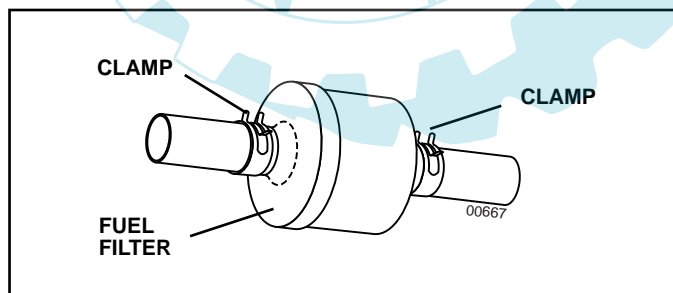

FIG. 13

## CLEANING

- Clean engine, battery, seat, finish, etc. of all foreign matter.
- Keep finished surfaces and wheels free of all gasoline, oil, etc.
- Protect painted surfaces with automotive type wax.

We do not recommend using a garden hose or pressure washer to clean your tractor unless the engine and transmission are covered to keep water out. Water in engine or transmission will shorten the useful life of your tractor. Use compressed air or a leaf blower to remove grass, leaves and trash from tractor and mower.



# SERVICE AND ADJUSTMENTS



**WARNING: TO AVOID SERIOUS INJURY, BEFORE PERFORMING ANY SERVICE OR ADJUSTMENTS:**

- Depress clutch/brake pedal fully and set parking brake.
- Place gearshift lever in neutral (N) position.
- Place attachment clutch in “DISENGAGED” position.
- Turn ignition key to “STOP” and remove key.
- Make sure the blades and all moving parts have completely stopped.
- Disconnect spark plug wire from spark plug and place wire where it cannot come in contact with plug.

## TRACTOR

### TO REMOVE MOWER (See Fig. 14)

Mower will be easier to remove from the right side of tractor.

- Place attachment clutch in “DISENGAGED” position.
- Move attachment lift lever forward to lower mower to its lowest position.
- Roll belt off engine pulley.
- Remove small retainer spring, and remove clutch spring off pulley bolt.
- Remove large retainer spring, slide collar off and push housing guide out of bracket.
- Disconnect anti-swaybar from chassis bracket by removing retainer spring.
- Disconnect suspension arms from rear deck brackets by removing retainer springs.
- Disconnect front links from deck by removing retainer springs.
- Raise lift lever to raise suspension arms. Slide mower out from under tractor.

**IMPORTANT: IF AN ATTACHMENT OTHER THAN THE MOWER DECK IS TO BE MOUNTED ON THE TRACTOR, REMOVE THE FRONT LINKS AND HOOK THE CLUTCH SPRING INTO SQUARE HOLE IN FRAME.**

### TO INSTALL MOWER (See Fig. 14)

- Raise attachment lift lever to its highest position.
- Slide mower under tractor with deflector shield to right side of tractor.
- Lower lift lever to its lowest position.
- Connect front links to mower deck and secure with retainer springs.
- Connect suspension arms to rear deck brackets and secure with retainer springs.
- Connect anti-swaybar to chassis bracket and secure with retainer spring.
- Push clutch cable housing guide into bracket, slide collar onto guide and secure with large retainer spring.
- Place flat washer and clutch spring on idler pulley bolt and secure with small retainer spring.
- Install belt onto engine pulley.

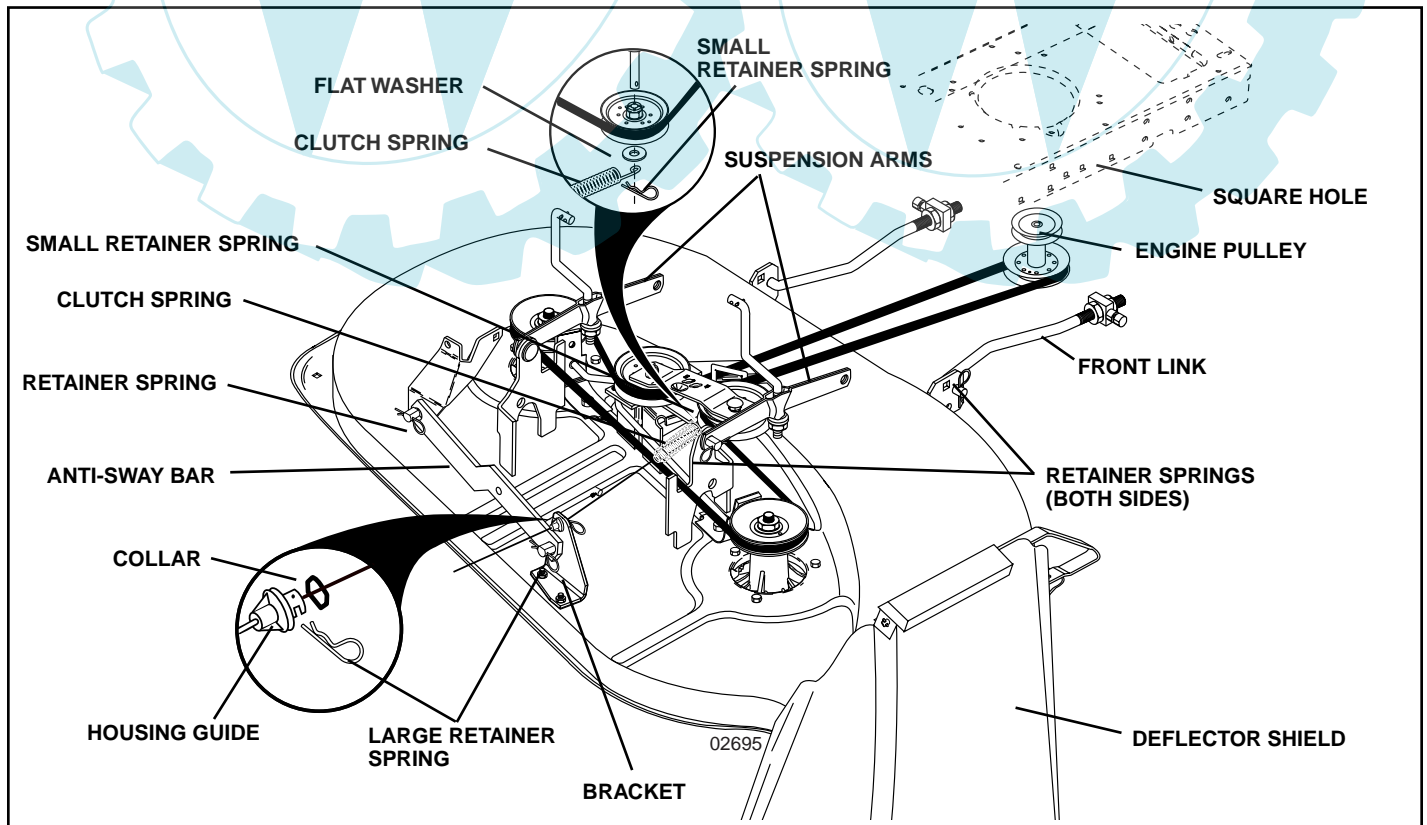

FIG. 14



# SERVICE AND ADJUSTMENTS

## TO LEVEL MOWER HOUSING

Adjust the mower while tractor is parked on level ground or driveway. Make sure tires are properly inflated (See "PRODUCT SPECIFICATIONS" section of this manual). If tires are over or underinflated, you will not properly adjust your mower.

SIDE-TO-SIDE ADJUSTMENT (See Figs. 15 and 16)

- Raise mower to its highest position.
- At the midpoint of both sides of mower, measure height from bottom edge of mower to ground. Distance "A" on both sides of mower should be the same or within 1/4" of each other.
- If adjustment is necessary, make adjustment on one side of mower only.
- To raise one side of mower, tighten lift link adjustment nut on that side.
- To lower one side of mower, loosen lift link adjustment nut on that side.

**NOTE:** Three full turns of adjustment nut will change mower height about 1/8".

- Recheck measurements after adjusting.

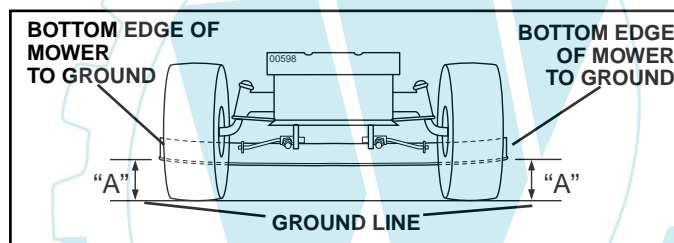

FIG. 15

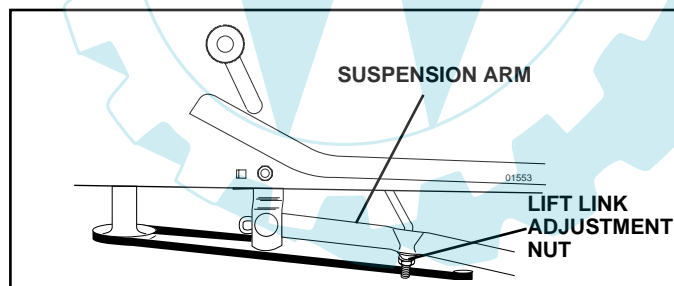

FIG. 16

FRONT-TO-BACK ADJUSTMENT (See Figs. 17 and 18)

**IMPORTANT:** DECK MUST BE LEVEL SIDE-TO-SIDE. IF THE FOLLOWING FRONT-TO-BACK ADJUSTMENT IS NECESSARY, BE SURE TO ADJUST BOTH FRONT LINKS EQUALLY SO MOWER WILL STAY LEVEL SIDE-TO-SIDE.

To obtain the best cutting results, the mower housing should be adjusted so that the front is approximately 1/8" to 1/2" lower than the rear when the mower is in its highest position.

Check adjustment on right side of tractor. Measure distance "D" directly in front and behind the mandrel at bottom edge of mower housing as shown.

- Before making any necessary adjustments, check that both front links are equal in length.
- If links are not equal in length, adjust one link to same length as other link.

- To lower front of mower loosen nut "E" on both front links an equal number of turns.
- When distance "D" is 1/8" to 1/2" lower at front than rear, tighten nuts "F" against trunnion on both front links.
- To raise front of mower, loosen nut "F" from trunnion on both front links. Tighten nut "E" on both front links an equal number of turns. The two front links must remain equal in length.
- When distance "D" is 1/8" to 1/2" lower at front than rear, tighten nut "F" against trunnion on both front links.
- Recheck side-to-side adjustment.

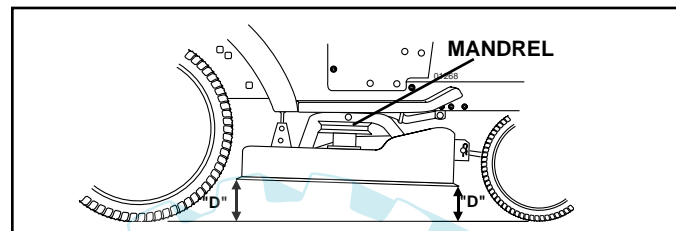

FIG. 17

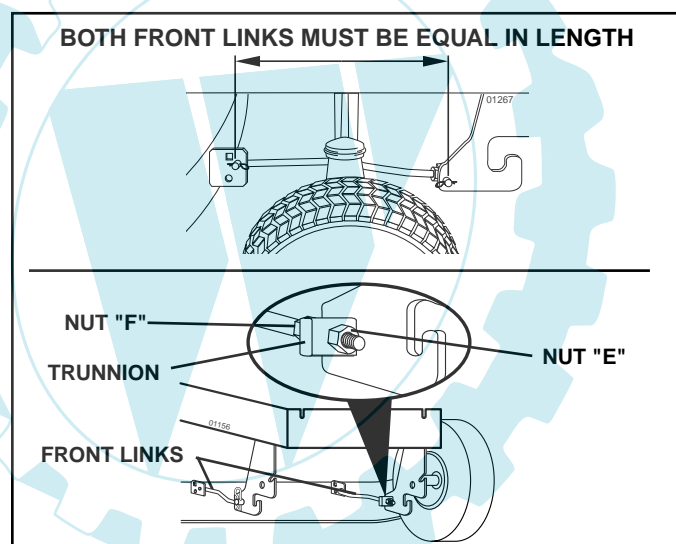

FIG. 18

## TO REPLACE MOWER BLADE DRIVE BELT (See Fig. 19)

The mower blade drive belt may be replaced without tools. Park the tractor on level surface. Engage parking brake.

BELT REMOVAL -

- Place attachment clutch in "DISENGAGED" position.
- Move attachment lift lever forward to lower mower to its lowest position.
- Roll belt off engine pulley.
- Disconnect R.H. suspension arm from rear deck bracket by removing retainer spring.
- Work belt off both mandrel pulleys and idler pulleys.
- Pull belt away from mower.

# SERVICE AND ADJUSTMENTS

## BELT INSTALLATION -

- Work new belt around both mandrel pulleys and idler pulleys.
- Install new belt into engine pulley groove.
- Reconnect R.H. suspension arm and secure with retainer spring.
- Make sure belt is in all pulley grooves and inside all belt guides.

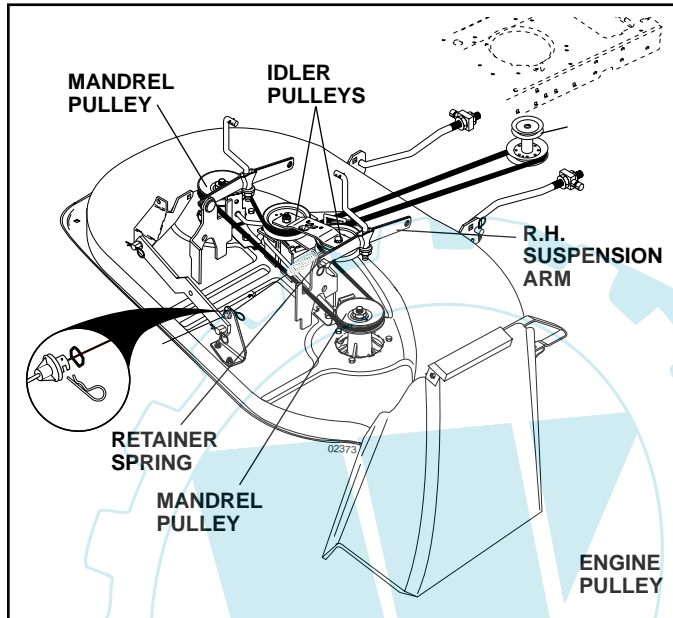

FIG. 19

## TO CHECK AND ADJUST BRAKE (See Fig. 20)

Your tractor is equipped with an adjustable brake system which is mounted on the right side of the transaxle.

If tractor requires more than five (5) feet to stop at highest speed in highest gear on a level, dry concrete or paved surface, then brake must be checked and adjusted.

### TO CHECK BRAKE

- Park tractor on a level, dry concrete or paved surface, depress clutch/brake pedal all the way down and engage parking brake.
- Place gear shift lever in neutral (N) position.

The rear wheels must lock and skid when you try to manually push the tractor forward. If the rear wheels rotate, the brake needs to be adjusted or the pads need to be replaced.

### TO ADJUST BRAKE

- Depress clutch/brake pedal all the way down and engage parking brake.
- Measure distance between brake operating arm and nut "A" on brake rod.
- If distance is other than 1-1/2", loosen jam nut and turn nut "A" until distance becomes 1-1/2". Retighten jam nut against nut "A".
- Road test tractor for proper stopping distance as stated above. Readjust if necessary. If stopping distance is still greater than five (5) feet in highest gear, further maintenance is necessary. Replace brake pads or contact a qualified service center.

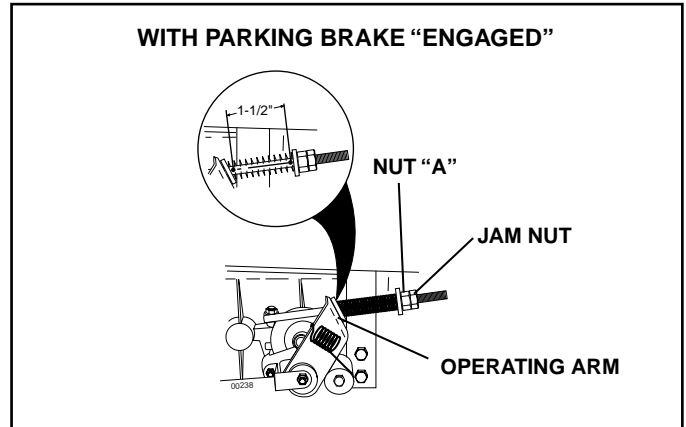

FIG. 20

## TO REPLACE MOTION DRIVE BELT (See Fig. 21)

Park the tractor on level surface. Engage parking brake. For assistance, there is a belt installation guide decal on bottom side of left footrest.

### BELT REMOVAL -

- Remove mower (See "TO REMOVE MOWER" in this section of manual).

**NOTE:** Observe entire motion drive belt and position of all belt guides and keepers.

- Remove belt from stationary idler and clutching idler.
- Remove belt downward from around engine pulley.
- Pull belt slack toward rear of tractor. Remove belt upwards from transaxle pulley by deflecting belt keepers.
- Remove belt from center span keeper and pull belt away from tractor.

### BELT INSTALLATION -

- Carefully work new belt down between transaxle belt keepers and onto the input pulley.
- Slide belt into the center span keeper.
- Pull belt toward front of tractor and roll around the top groove of engine pulley.
- Install belt through stationary idler and clutching idler.
- Make sure belt is in all pulley grooves and inside all belt guides and keepers.
- Install mower (See "TO INSTALL MOWER" in this section of manual).

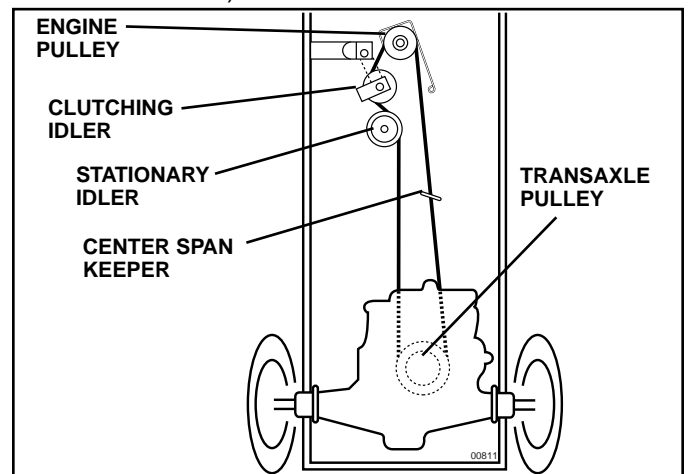

FIG. 21

# SERVICE AND ADJUSTMENTS

## TO ADJUST STEERING WHEEL ALIGNMENT

If steering wheel crossbars are not horizontal (left to right) when wheels are positioned straight forward, remove steering wheel and reassemble per instructions in the Assembly section of this manual.

## FRONT WHEEL TOE-IN/CAMBER

The front wheel toe-in and camber are not adjustable on your tractor. If damage has occurred to affect the front wheel toe-in or camber, contact your nearest authorized service center/department.

## TO REMOVE WHEEL FOR REPAIRS

(See Fig. 22)

- Block up axle securely.
- Remove axle cover, retaining ring and washers to allow wheel removal (rear wheel contains a square key - Do not lose).
- Repair tire and reassemble.
- On rear wheels only: align grooves in rear wheel hub and axle. Insert square key.
- Replace washers and snap retaining ring securely in axle groove.
- Replace axle cover.

**NOTE:** To seal tire punctures and prevent flat tires due to slow leaks, tire sealant may be purchased from your local parts dealer. Tire sealant also prevents tire dry rot and corrosion.

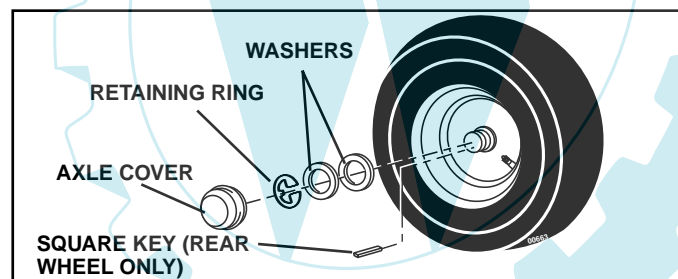

FIG. 22

## TO START ENGINE WITH A WEAK BATTERY

(See Fig. 23)



**WARNING:** Lead-acid batteries generate explosive gases. Keep sparks, flame and smoking materials away from batteries. Always wear eye protection when around batteries.

If your battery is too weak to start the engine, it should be recharged. (See "BATTERY" in the MAINTENANCE section of this manual).

If "jumper cables" are used for emergency starting, follow this procedure:

**IMPORTANT:** YOUR TRACTOR IS EQUIPPED WITH A 12 VOLT SYSTEM. THE OTHER VEHICLE MUST ALSO BE A 12 VOLT SYSTEM. DO NOT USE YOUR TRACTOR BATTERY TO START OTHER VEHICLES.

### TO ATTACH JUMPER CABLES -

- Connect one end of the RED cable to the POSITIVE (+) terminal of each battery (A-B), taking care not to short against tractor chassis.

- Connect one end of the BLACK cable to the NEGATIVE (-) terminal (C) of fully charged battery.
- Connect the other end of the BLACK cable (D) to good chassis ground, away from fuel tank and battery.

### TO REMOVE CABLES, REVERSE ORDER -

- BLACK cable first from chassis and then from the fully charged battery.
- RED cable last from both batteries.

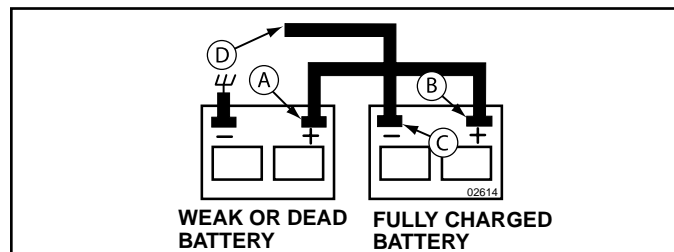

FIG. 23

## INTERLOCKS AND RELAYS

Loose or damaged wiring may cause your tractor to run poorly, stop running, or prevent it from starting.

- Check wiring. See electrical wiring diagram in the Repair Parts section.

## TO REPLACE FUSE

Replace with 20 amp automotive-type plug-in fuse. The fuse holder is located behind the dash.

## TO REMOVE HOOD AND GRILL ASSEMBLY

(See Fig. 24)

- Raise hood.
- Stand in front of tractor. Grasp hood at sides, tilt toward engine and lift off of tractor.
- To replace, reverse above procedure.

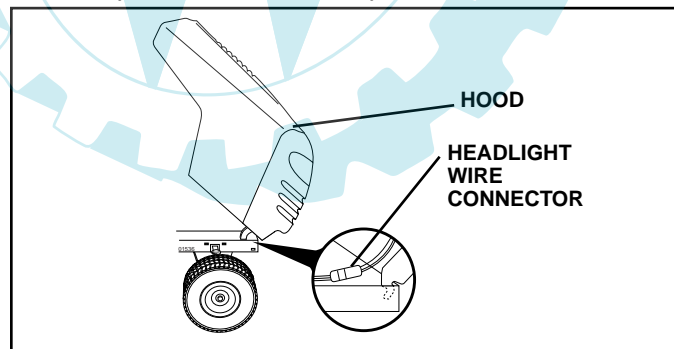

FIG. 24

## ENGINE

### TO ADJUST THROTTLE CONTROL CABLE

The throttle control has been preset at the factory and adjustment should not be necessary. If adjustment is necessary, see engine manual.

### TO ADJUST CARBURETOR

The carburetor has been preset at the factory and adjustment should not be necessary. However, minor adjustment may be required to compensate for differences in fuel, temperature, altitude or load. If the carburetor does need adjustment, see engine manual.

# STORAGE

Immediately prepare your tractor for storage at the end of the season or if the tractor will not be used for 30 days or more.



**WARNING: Never store the tractor with gasoline in the tank inside a building where fumes may reach an open flame or spark. Allow the engine to cool before storing in any enclosure.**

## TRACTOR

Remove mower from tractor for winter storage. When mower is to be stored for a period of time, clean it thoroughly, remove all dirt, grease, leaves, etc. Store in a clean, dry area.

- Clean entire tractor (See "CLEANING" in the Maintenance section of this manual).
- Inspect and replace belts, if necessary (See belt replacement instructions in the Service and Adjustments section of this manual).
- Lubricate as shown in the Maintenance section of this manual.
- Be sure that all nuts, bolts and screws are securely fastened. Inspect moving parts for damage, breakage and wear. Replace if necessary.
- Touch up all rusted or chipped paint surfaces; sand lightly before painting.

## BATTERY

- Fully charge the battery for storage.
- After a period of time in storage, battery may require recharging.
- To help prevent corrosion and power leakage during long periods of storage, battery cables should be disconnected and battery cleaned thoroughly (see "TO CLEAN BATTERY AND TERMINALS" in the Maintenance section of this manual).
- After cleaning, leave cables disconnected and place cables where they cannot come in contact with battery terminals.
- If battery is removed from tractor for storage, do not store battery directly on concrete or damp surfaces.

## ENGINE

### FUEL SYSTEM

**IMPORTANT:** IT IS IMPORTANT TO PREVENT GUM DEPOSITS FROM FORMING IN ESSENTIAL FUEL SYSTEM PARTS SUCH AS CARBURETOR, FUEL FILTER, FUEL HOSE, OR TANK DURING STORAGE. ALSO, EXPERIENCE INDICATES THAT ALCOHOL BLENDED FUELS (CALLED GASOHOL OR USING ETHANOL OR METHANOL) CAN ATTRACT MOISTURE WHICH LEADS TO SEPARATION AND FORMATION OF ACIDS DURING STORAGE. ACIDIC GAS CAN DAMAGE THE FUEL SYSTEM OF AN ENGINE WHILE IN STORAGE.

- Empty the fuel tank by starting the engine and let it run until the fuel lines and carburetor are empty.
- Never use engine or carburetor cleaner products in the fuel tank or permanent damage may occur.
- Use fresh fuel next season.

**NOTE:** Fuel stabilizer is an acceptable alternative in minimizing the formation of fuel gum deposits during storage. Add stabilizer to gasoline in fuel tank or storage container. Always follow the mix ratio found on stabilizer container. Run engine at least 10 minutes after adding stabilizer to allow the stabilizer to reach the carburetor. Do not empty the gas tank and carburetor if using fuel stabilizer.

### ENGINE OIL

Drain oil (with engine warm) and replace with clean engine oil. (See "ENGINE" in the Maintenance section of this manual).

### CYLINDER(S)

- Remove spark plug(s).
- Pour one ounce of oil through spark plug hole(s) into cylinder(s).
- Turn ignition key to "START" position for a few seconds to distribute oil.
- Replace with new spark plug(s).

### OTHER

- Do not store gasoline from one season to another.
- Replace your gasoline can if your can starts to rust. Rust and/or dirt in your gasoline will cause problems.
- If possible, store your tractor indoors and cover it to give protection from dust and dirt.
- Cover your tractor with a suitable protective cover that does not retain moisture. Do not use plastic. Plastic cannot breathe which allows condensation to form and will cause your tractor to rust.

**IMPORTANT:** NEVER COVER TRACTOR WHILE ENGINE AND EXHAUST AREAS ARE STILL WARM.



# TROUBLESHOOTING POINTS

PROBLEM	CAUSE	CORRECTION
<b>Will not start</b>	<ol style="list-style-type: none"> <li>1. Out of fuel.</li> <li>2. Engine not "CHOKED" properly.</li> <li>3. Engine flooded.</li> <li>4. Bad spark plug.</li> <li>5. Dirty air filter.</li> <li>6. Dirty fuel filter.</li> <li>7. Water in fuel.</li> <li>8. Loose or damaged wiring.</li> <li>9. Carburetor out of adjustment.</li> <li>10. Engine valves out of adjustment.</li> </ol>	<ol style="list-style-type: none"> <li>1. Fill fuel tank.</li> <li>2. See "TO START ENGINE" in Operation section.</li> <li>3. Wait several minutes before attempting to start.</li> <li>4. Replace spark plug.</li> <li>5. Clean/replace air filter.</li> <li>6. Replace fuel filter.</li> <li>7. Empty fuel tank and carburetor, refill tank with fresh gasoline and replace fuel filter.</li> <li>8. Check all wiring.</li> <li>9. See "To Adjust Carburetor" in Service Adjustments section.</li> <li>10. Contact an authorized service center/department.</li> </ol>
<b>Hard to start</b>	<ol style="list-style-type: none"> <li>1. Dirty air filter.</li> <li>2. Bad spark plug.</li> <li>3. Weak or dead battery.</li> <li>4. Dirty fuel filter.</li> <li>5. Stale or dirty fuel.</li> <li>6. Loose or damaged wiring.</li> <li>7. Carburetor out of adjustment.</li> <li>8. Engine valves out of adjustment.</li> </ol>	<ol style="list-style-type: none"> <li>1. Clean/replace air filter.</li> <li>2. Replace spark plug.</li> <li>3. Recharge or replace battery.</li> <li>4. Replace fuel filter.</li> <li>5. Empty fuel tank and refill tank with fresh, clean gasoline.</li> <li>6. Check all wiring.</li> <li>7. See "To Adjust Carburetor" in Service Adjustments section.</li> <li>8. Contact an authorized service center/department.</li> </ol>
<b>Engine will not turn over</b>	<ol style="list-style-type: none"> <li>1. Clutch/brake pedal not depressed.</li> <li>2. Attachment clutch is engaged.</li> <li>3. Weak or dead battery.</li> <li>4. Blown fuse.</li> <li>5. Corroded battery terminals.</li> <li>6. Loose or damaged wiring.</li> <li>7. Faulty ignition switch.</li> <li>8. Faulty solenoid or starter.</li> <li>9. Faulty operator presence switch(es).</li> </ol>	<ol style="list-style-type: none"> <li>1. Depress clutch/brake pedal.</li> <li>2. Disengage attachment clutch.</li> <li>3. Recharge or replace battery.</li> <li>4. Replace fuse.</li> <li>5. Clean battery terminals.</li> <li>6. Check all wiring.</li> <li>7. Check/replace ignition switch.</li> <li>8. Check/replace solenoid or starter.</li> <li>9. Contact an authorized service center/department.</li> </ol>
<b>Engine clicks but will not start</b>	<ol style="list-style-type: none"> <li>1. Weak or dead battery.</li> <li>2. Corroded battery terminals.</li> <li>3. Loose or damaged wiring.</li> <li>4. Faulty solenoid or starter.</li> </ol>	<ol style="list-style-type: none"> <li>1. Recharge or replace battery.</li> <li>2. Clean battery terminals.</li> <li>3. Check all wiring.</li> <li>4. Check/replace solenoid or starter.</li> </ol>
<b>Loss of power</b>	<ol style="list-style-type: none"> <li>1. Cutting too much grass/too fast.</li> <li>2. Throttle in "CHOKE" position.</li> <li>3. Build-up of grass, leaves and trash under mower.</li> <li>4. Dirty air filter.</li> <li>5. Low oil level/dirty oil.</li> <li>6. Faulty spark plug.</li> <li>7. Dirty fuel filter.</li> <li>8. Stale or dirty fuel.</li> <li>9. Water in fuel.</li> <li>10. Spark plug wire loose.</li> <li>11. Dirty engine air screen/fins.</li> <li>12. Dirty/clogged muffler.</li> <li>13. Loose or damaged wiring.</li> <li>14. Carburetor out of adjustment.</li> <li>15. Engine valves out of adjustment.</li> </ol>	<ol style="list-style-type: none"> <li>1. Raise cutting height/reduce speed.</li> <li>2. Adjust throttle control.</li> <li>3. Clean underside of mower housing.</li> <li>4. Clean/replace air filter.</li> <li>5. Check oil level/change oil.</li> <li>6. Clean and regap or change spark plug.</li> <li>7. Replace fuel filter.</li> <li>8. Empty fuel tank and refill tank with fresh, clean gasoline.</li> <li>9. Empty fuel tank and carburetor, refill tank with fresh gasoline and replace fuel filter.</li> <li>10. Connect and tighten spark plug wire.</li> <li>11. Clean engine air screen/fins.</li> <li>12. Clean/replace muffler.</li> <li>13. Check all wiring.</li> <li>14. See "To Adjust Carburetor" in Service Adjustments section.</li> <li>15. Contact an authorized service center/department.</li> </ol>
<b>Excessive vibration</b>	<ol style="list-style-type: none"> <li>1. Worn, bent or loose blade.</li> <li>2. Bent blade mandrel.</li> <li>3. Loose/damaged part(s).</li> </ol>	<ol style="list-style-type: none"> <li>1. Replace blade. Tighten blade bolt.</li> <li>2. Replace blade mandrel.</li> <li>3. Tighten loose part(s). Replace damaged parts.</li> </ol>



# TROUBLESHOOTING POINTS

PROBLEM	CAUSE	CORRECTION
<b>Engine continues to run when operator leaves seat with attachment clutch engaged</b>	<ol style="list-style-type: none"> <li>1. Faulty operator-safety presence control system.</li> </ol>	<ol style="list-style-type: none"> <li>1. Check wiring, switches and connections. If not corrected, contact an authorized service center/department.</li> </ol>
<b>Poor cut - uneven</b>	<ol style="list-style-type: none"> <li>1. Worn, bent or loose blade.</li> <li>2. Mower deck not level.</li> <li>3. Buildup of grass, leaves, and trash under mower.</li> <li>4. Bent blade mandrel.</li> <li>5. Clogged mower deck vent holes from buildup of grass, leaves, and trash around mandrels.</li> </ol>	<ol style="list-style-type: none"> <li>1. Replace blade. Tighten blade bolt.</li> <li>2. Level mower deck.</li> <li>3. Clean underside of mower housing.</li> <li>4. Replace blade mandrel.</li> <li>5. Clean around mandrels to open vent holes.</li> </ol>
<b>Mower blades will not rotate</b>	<ol style="list-style-type: none"> <li>1. Obstruction in clutch mechanism.</li> <li>2. Worn/damaged mower drive belt.</li> <li>3. Frozen idler pulley.</li> <li>4. Frozen blade mandrel.</li> </ol>	<ol style="list-style-type: none"> <li>1. Remove obstruction.</li> <li>2. Replace mower drive belt.</li> <li>3. Replace idler pulley.</li> <li>4. Replace blade mandrel.</li> </ol>
<b>Poor grass discharge</b>	<ol style="list-style-type: none"> <li>1. Engine speed too slow.</li> <li>2. Travel speed too fast.</li> <li>3. Wet grass.</li> <li>4. Mower deck not level.</li> <li>5. Low/uneven tire air pressure.</li> <li>6. Worn, bent or loose blade.</li> <li>7. Buildup of grass, leaves and trash under mower.</li> <li>8. Mower drive belt worn.</li> <li>9. Blades improperly installed.</li> <li>10. Improper blades used.</li> <li>11. Clogged mower deck vent holes from buildup of grass, leaves, and trash around mandrels.</li> </ol>	<ol style="list-style-type: none"> <li>1. Place throttle control in "FAST" position.</li> <li>2. Shift to slower speed.</li> <li>3. Allow grass to dry before mowing.</li> <li>4. Level mower deck.</li> <li>5. Check tires for proper air pressure.</li> <li>6. Replace/sharpen blade. Tighten blade bolt.</li> <li>7. Clean underside of mower housing.</li> <li>8. Replace mower drive belt.</li> <li>9. Reinstall blades sharp edge down.</li> <li>10. Replace with blades listed in this manual.</li> <li>11. Clean around mandrels to open vent holes.</li> </ol>
<b>Headlight(s) not working (if so equipped)</b>	<ol style="list-style-type: none"> <li>1. Switch is "OFF".</li> <li>2. Bulb(s) or lamp(s) burned out.</li> <li>3. Faulty light switch.</li> <li>4. Loose or damaged wiring.</li> <li>5. Blown fuse.</li> </ol>	<ol style="list-style-type: none"> <li>1. Turn switch "ON".</li> <li>2. Replace bulb(s) or lamp(s).</li> <li>3. Check/replace light switch.</li> <li>4. Check wiring and connections.</li> <li>5. Replace fuse.</li> </ol>
<b>Battery will not charge</b>	<ol style="list-style-type: none"> <li>1. Bad battery cell(s).</li> <li>2. Poor cable connections.</li> <li>3. Faulty regulator (if so equipped).</li> <li>4. Faulty alternator.</li> </ol>	<ol style="list-style-type: none"> <li>1. Replace battery.</li> <li>2. Check/clean all connections.</li> <li>3. Replace regulator.</li> <li>4. Replace alternator.</li> </ol>
<b>Engine "backfires" when turning engine "OFF"</b>	<ol style="list-style-type: none"> <li>1. Engine throttle control not set between half and full speed (fast) position before stopping engine.</li> </ol>	<ol style="list-style-type: none"> <li>1. Move throttle control between half and full speed (fast) position before stopping engine.</li> </ol>

**TRACTOR -- MODEL NUMBER MC1538ST (MC1538STA), PRODUCT NO. 964 77 28-03  
SCHEMATIC**

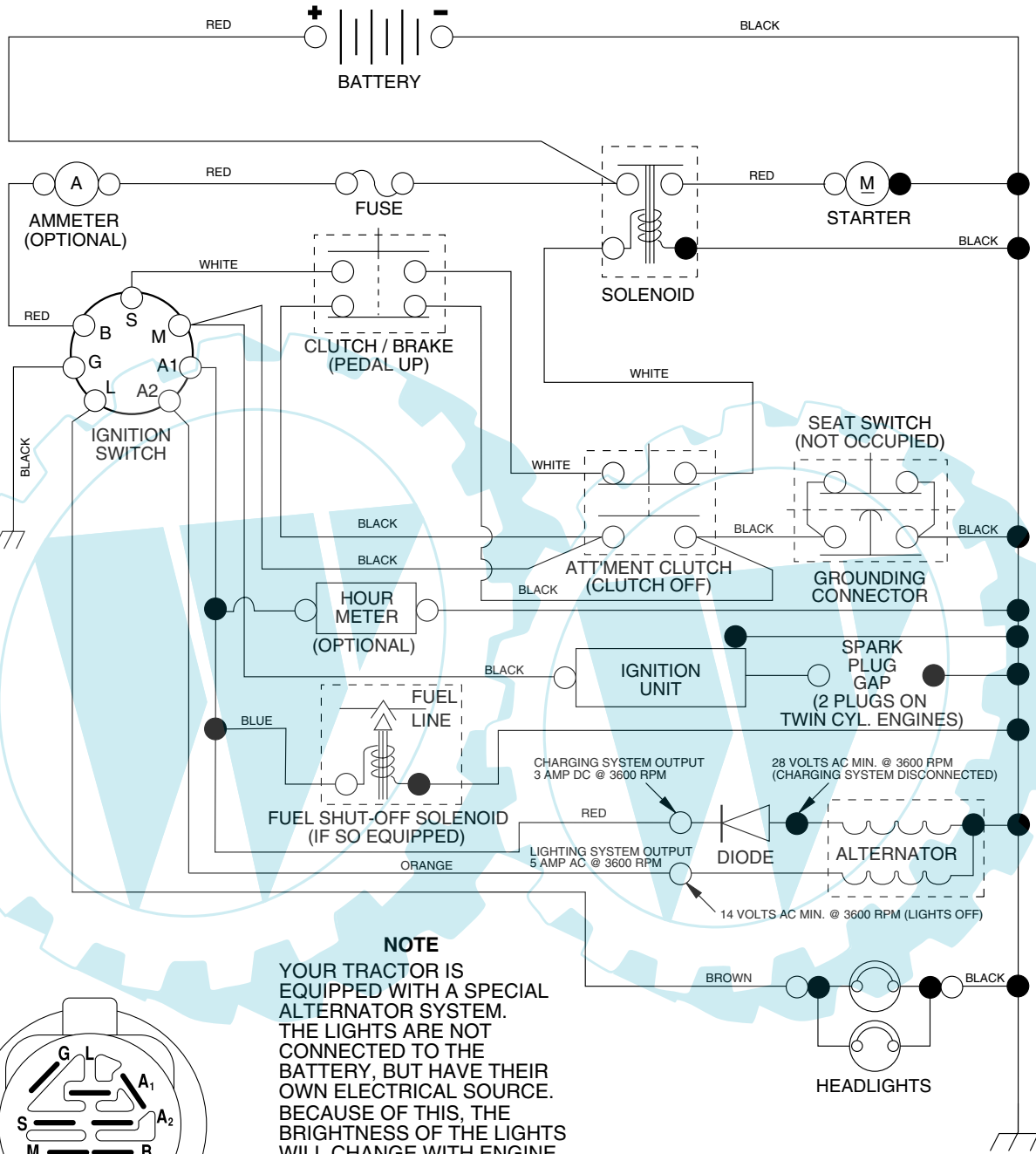

**NOTE**  
YOUR TRACTOR IS EQUIPPED WITH A SPECIAL ALTERNATOR SYSTEM. THE LIGHTS ARE NOT CONNECTED TO THE BATTERY, BUT HAVE THEIR OWN ELECTRICAL SOURCE. BECAUSE OF THIS, THE BRIGHTNESS OF THE LIGHTS WILL CHANGE WITH ENGINE SPEED. AT IDLE THE LIGHTS WILL DIM. AS THE ENGINE IS SPEEDED UP, THE LIGHTS WILL BECOME THEIR BRIGHTEST.

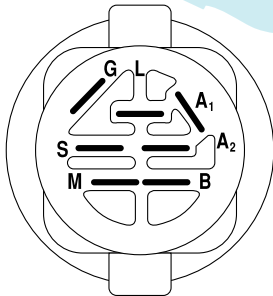

**IGNITION SWITCH**

POSITION	CIRCUIT	"MAKE"
OFF	M+G+A1	NONE
RUN/LIGHT	B+A1	A2+L
RUN	B+A1	NONE
START	B + S + A1	NONE

**WIRING INSULATED CLIPS**

**NOTE:** IF WIRING INSULATED CLIPS WERE REMOVED FOR SERVICING OF UNIT, THEY SHOULD BE REPLACED TO PROPERLY SECURE YOUR WIRING.

02363

# REPAIR PARTS

TRACTOR -- MODEL NUMBER MC1538ST (MC1538STA), PRODUCT NO. 964 77 28-03  
ELECTRICAL

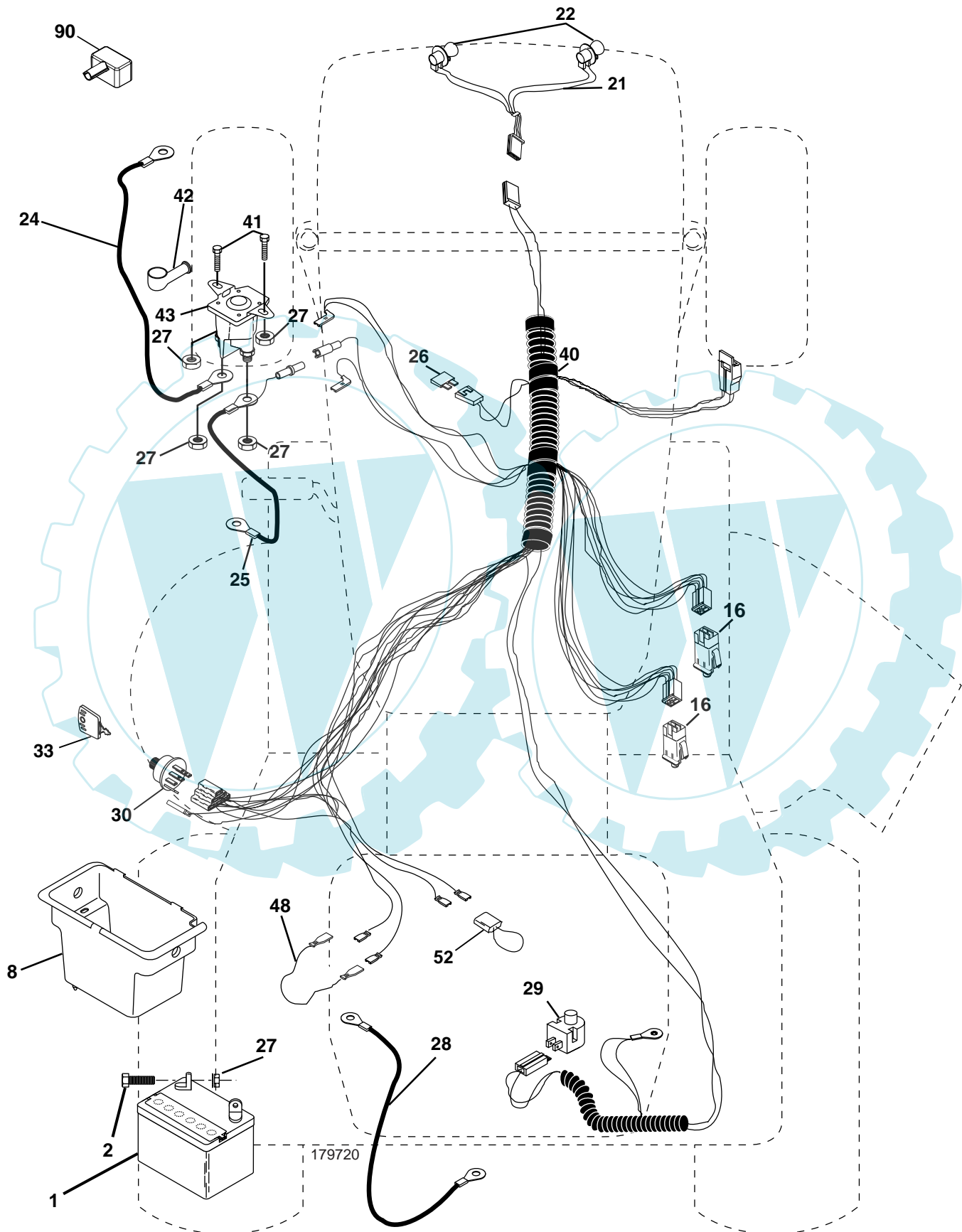

## REPAIR PARTS

TRACTOR - - MODEL NUMBER MC1538ST (MC1538STA), PRODUCT NO. 964 77 28-03  
ELECTRICAL

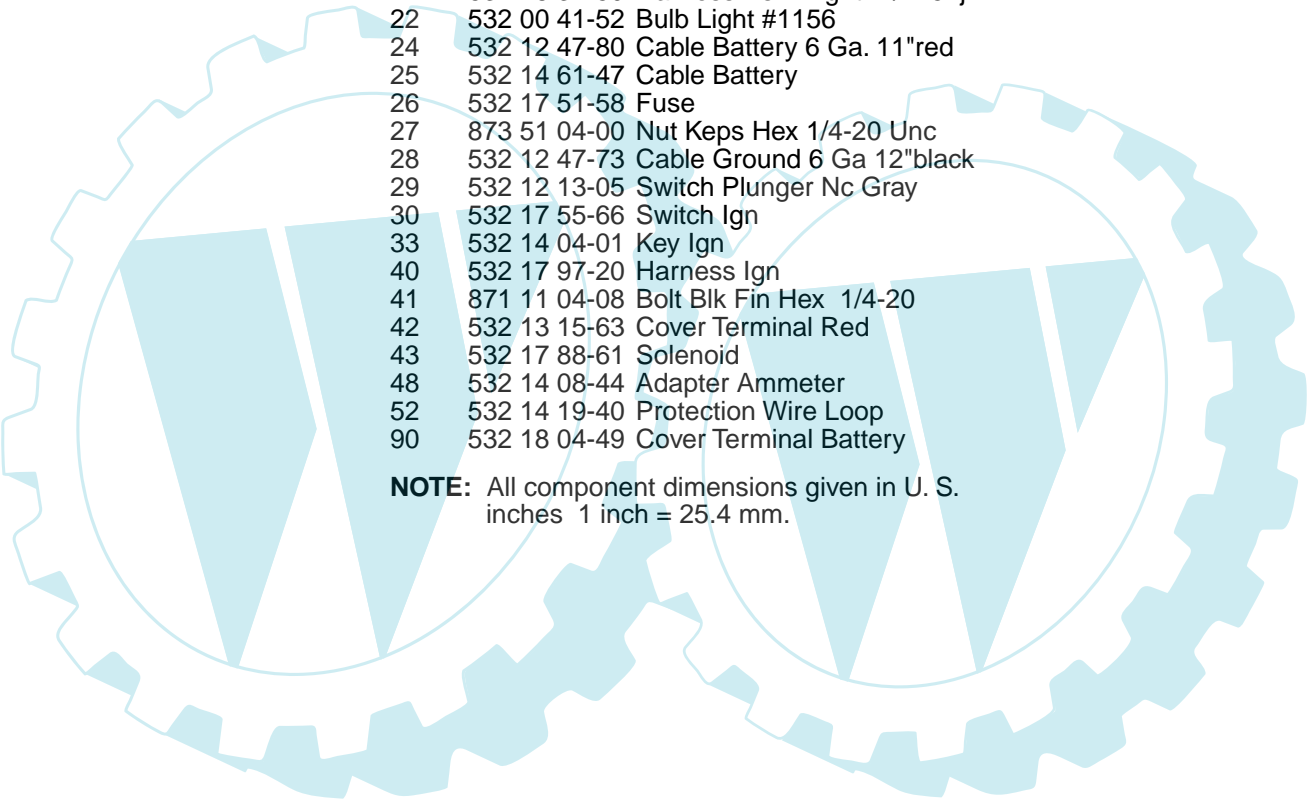

KEY NO.	PART NO.	DESCRIPTION
1	532 16 34-65	Battery 12 Volt 25 Amp
2	874 76 04-12	Bolt Hex Hd 1/4-20 unc x 3/4
8	532 17 66-89	Case Battery Mech Hiinge
16	532 17 61-38	Switch Interlock Push-In
21	532 18 37-59	Harness Asm Light W/4152j
22	532 00 41-52	Bulb Light #1156
24	532 12 47-80	Cable Battery 6 Ga. 11"red
25	532 14 61-47	Cable Battery
26	532 17 51-58	Fuse
27	873 51 04-00	Nut Keps Hex 1/4-20 Unc
28	532 12 47-73	Cable Ground 6 Ga 12"black
29	532 12 13-05	Switch Plunger Nc Gray
30	532 17 55-66	Switch Ign
33	532 14 04-01	Key Ign
40	532 17 97-20	Harness Ign
41	871 11 04-08	Bolt Blk Fin Hex 1/4-20
42	532 13 15-63	Cover Terminal Red
43	532 17 88-61	Solenoid
48	532 14 08-44	Adapter Ammeter
52	532 14 19-40	Protection Wire Loop
90	532 18 04-49	Cover Terminal Battery

**NOTE:** All component dimensions given in U. S.  
inches 1 inch = 25.4 mm.



# REPAIR PARTS

TRACTOR -- MODEL NUMBER MC1538ST (MC1538STA), PRODUCT NO. 964 77 28-03  
CHASSIS

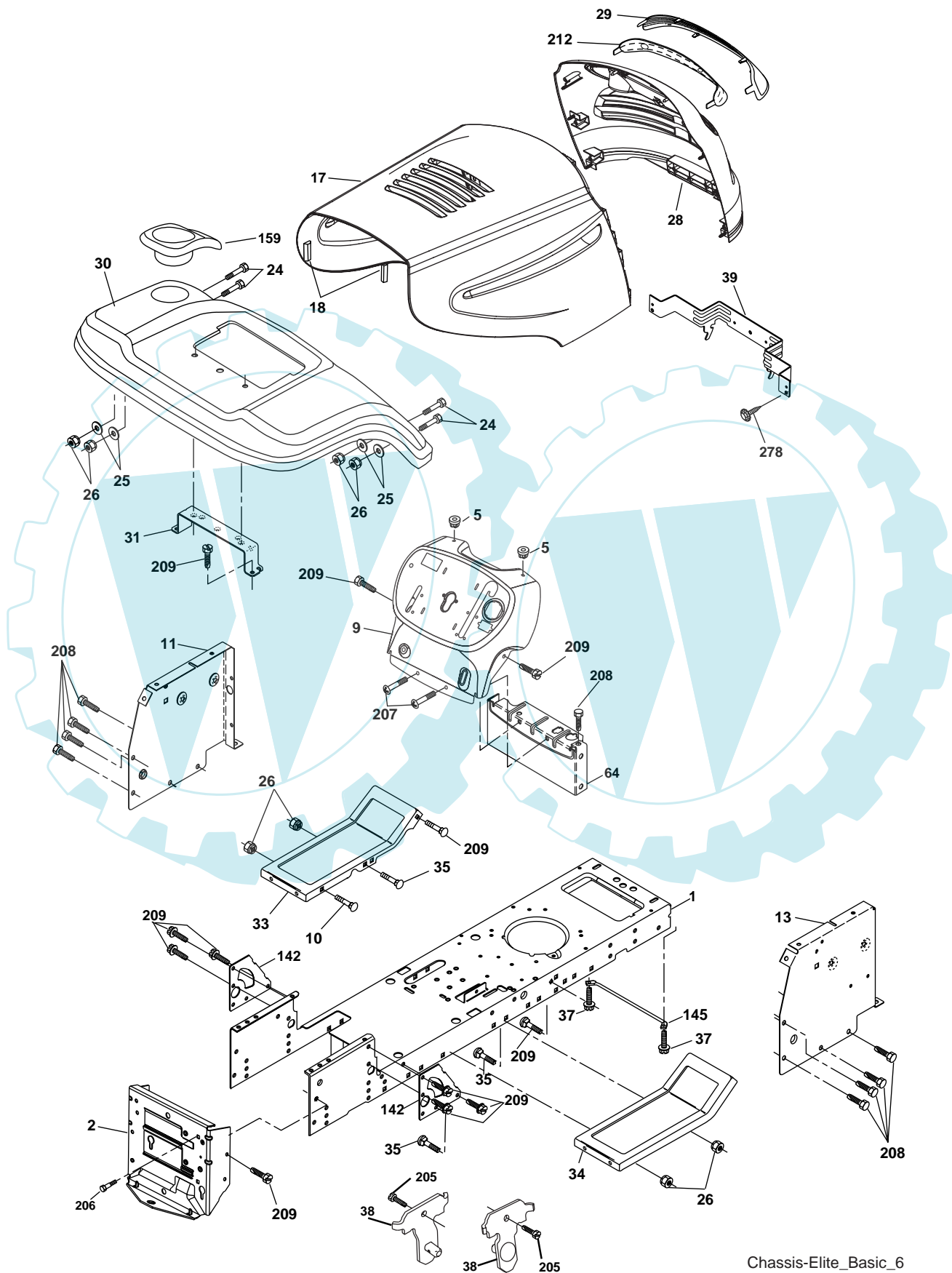

Chassis-Elite\_Basic\_6

## REPAIR PARTS

TRACTOR -- MODEL NUMBER MC1538ST (MC1538STA), PRODUCT NO. 964 77 28-03  
CHASSIS

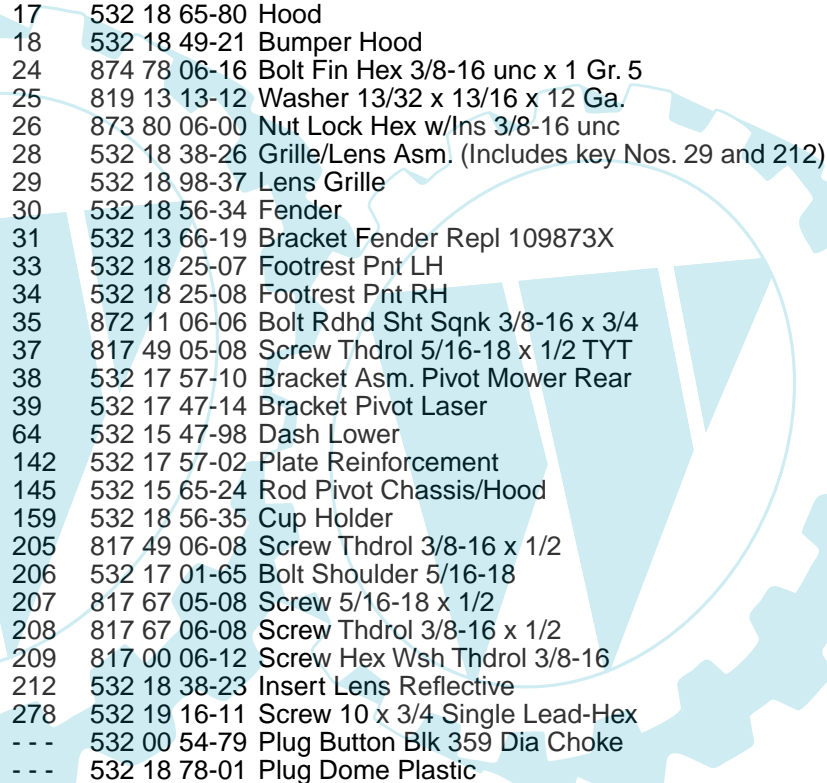

KEY NO.	PART NO.	DESCRIPTION
1	532 17 46-19	Chassis
2	532 17 65-54	Drawbar
5	532 15 52-72	Bumper, Hood/Dash
9	532 19 32-46	Dash
10	872 14 06-08	Bolt, Carriage 3/8-16 x 1
11	532 17 49-96	Panel Dash LH
13	532 18 69-52	Panel Silkscr Dash RH
17	532 18 65-80	Hood
18	532 18 49-21	Bumper Hood
24	874 78 06-16	Bolt Fin Hex 3/8-16 unc x 1 Gr. 5
25	819 13 13-12	Washer 13/32 x 13/16 x 12 Ga.
26	873 80 06-00	Nut Lock Hex w/lms 3/8-16 unc
28	532 18 38-26	Grille/Lens Asm. (Includes key Nos. 29 and 212)
29	532 18 98-37	Lens Grille
30	532 18 56-34	Fender
31	532 13 66-19	Bracket Fender Repl 109873X
33	532 18 25-07	Footrest Pnt LH
34	532 18 25-08	Footrest Pnt RH
35	872 11 06-06	Bolt Rdhd Sht Sqnk 3/8-16 x 3/4
37	817 49 05-08	Screw Thdrol 5/16-18 x 1/2 TYT
38	532 17 57-10	Bracket Asm. Pivot Mower Rear
39	532 17 47-14	Bracket Pivot Laser
64	532 15 47-98	Dash Lower
142	532 17 57-02	Plate Reinforcement
145	532 15 65-24	Rod Pivot Chassis/Hood
159	532 18 56-35	Cup Holder
205	817 49 06-08	Screw Thdrol 3/8-16 x 1/2
206	532 17 01-65	Bolt Shoulder 5/16-18
207	817 67 05-08	Screw 5/16-18 x 1/2
208	817 67 06-08	Screw Thdrol 3/8-16 x 1/2
209	817 00 06-12	Screw Hex Wsh Thdrol 3/8-16
212	532 18 38-23	Insert Lens Reflective
278	532 19 16-11	Screw 10 x 3/4 Single Lead-Hex
---	532 00 54-79	Plug Button Blk 359 Dia Choke
---	532 18 78-01	Plug Dome Plastic

**NOTE:** All component dimensions given in U.S. inches  
1 inch = 25.4 mm.

# REPAIR PARTS

TRACTOR -- MODEL NUMBER MC1538ST (MC1538STA), PRODUCT NO. 964 77 28-03  
DRIVE

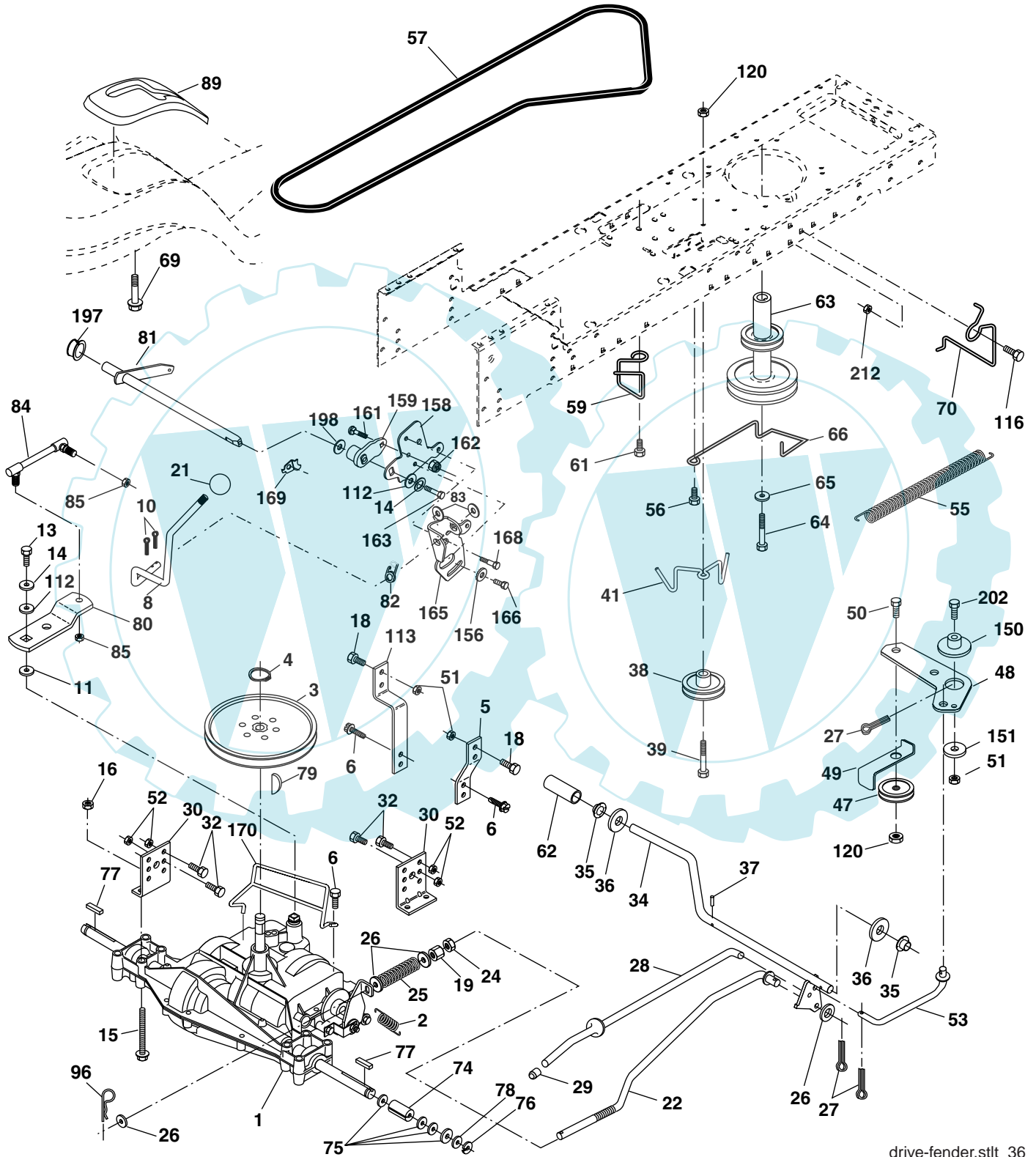

drive-fender.stlt\_36

# REPAIR PARTS

## TRACTOR -- MODEL NUMBER MC1538ST (MC1538STA), PRODUCT NO. 964 77 28-03 DRIVE

KEY NO.	PART NO.	DESCRIPTION	KEY NO.	PART NO.	DESCRIPTION
1	-----	Transaxle, Peerless 206-545C (Order parts from transaxle manufacturer)	62	532 12 48-72	Cover Pedal Blk Round
2	532 14 66-82	Spring Return Brake T/a Zinc	63	532 17 54-10	Engine Pulley
3	532 12 36-66	Pulley Transaxle 18" tires	64	532 17 39-37	Bolt Hex 7/16-20 x 4 x Gr. 5-1.5 THR
4	812 00 00-28	Ring Retainer # 5100-62	65	810 04 07-00	Washer Lock Hvy Hlcl Spr 7/16
5	532 12 15-20	Strap Torque 30 Degrees	66	532 15 47-78	Keeper Belt Engine Foolproof
6	817 06 05-12	Screw 5/16-18 x 3/4	69	532 14 24-32	Screw Hex Wsh Hi-Lo 1/4-1/2 unc
8	532 16 56-19	Rod Shifter Fender Adj Lt	70	532 13 46-83	Guide Belt Mower Drive RH
10	876 02 04-16	Pin Cotter 1/8 x 1 Cad	74	532 13 70-57	Spacer Axle
11	532 10 57-01	Washer Plate Shf 388 Sq Hole	75	532 12 17-49	Washer 25/32 x 1 1/4 x 16 Ga.
13	874 55 04-12	Bolt 1/4-28 unf Gr. 8 W/Patch	76	812 00 00-01	E-ring #5133-75
14	810 04 04-00	Washer Lock Hvy Helical 1/4	77	532 12 35-83	Key Square 2 0 x 1845/ 1865
15	874 49 05-44	Bolt Hex FLGHD 5/16-18 Gr. 5	78	532 12 17-48	Washer 25/32 x 1-5/8 x 16 Ga.
16	873 80 05-00	Nut Lock	79	532 12 50-96	Key Woodruff
18	874 78 06-16	Bolt, Fin Hex 3/8-16 unc x 1 Gr. 5	80	532 13 14-86	Arm Shift
19	873 80 06-00	Nut Lock 3/8-16 Unc	81	532 16 55-94	Shaft Asm Cross Tapered 20"t
21	532 10 69-33	Knob	82	532 12 37-82	Spring Torsion T/a
22	532 13 08-04	Rod Brake Blk Zinc 26 840	83	819 17 12-16	Washer 17/32 x 3/4 x 16 Ga.
24	873 35 06-00	Nut Hex Jam 3/8-16 unc	84	532 16 62-28	Link Transaxle
25	532 10 68-88	Spring Rod Brake 2 00 Zinc	85	532 15 03-60	Nut Lock Center 1/4 - 28 FNTHD
26	819 13 13-16	Washer 13/32 x 13/16 x 16 Ga.	89	532 18 30-43	Console Shift LT
27	876 02 04-12	Pin Cotter 1/8 x 3/4 Cad	96	532 12 47-88	Retainer Spring
28	532 17 57-65	Rod Brake Parking	112	819 09 12-10	Washer 9/32 x 3/4 x 10 Ga.
29	532 07 16-73	Cap Brake Parking	113	532 12 72-85	Strap Torque Lh
30	532 17 49-73	Bracket Mtg Transaxle	116	872 14 06-08	Bolt Rdhd Sq Neck 3/8-16 x 1.00
32	874 76 05-12	Bolt Hex Hd 5/16-18 unc x 3/4	120	873 90 06-00	Nut Lock Flg 3/8-16
34	532 17 55-78	Shaft Asm Pedal Foot	150	532 17 54-56	Spacer Retainer
35	532 12 01-83	Bearing Nylon Blk 629 Id	151	819 13 32-10	Washer 13/32 x 2 x 10
36	819 21 16-16	Washer 21/32 x 1 x 16 Ga.	156	532 16 60-02	Washer Srrted 5/16 ID x 1.125
37	532 12 49-63	Pin Roll 3/16 x 1"	158	532 16 55-89	Bracket Shift Mount
38	532 17 91-14	Pulley Idler Composite	159	532 18 39-00	Hub Tapered Flange Shift It
39	872 11 06-22	Bolt RDHD 3/8-16 unc x 2-3/4 Gr. 5	161	872 14 04-06	Bolt Rdhd Sqnk 1/4-20 x 3/4 Gr. 5
41	532 17 55-56	Keeper Belt Retainer Idler	162	873 68 04-00	Nut Crownlock 1/4-20 unc
47	532 12 77-83	Pulley Idler V Groove Plastic	163	874 78 04-16	Bolt Hex Fin 1/4-20 unc x 1 Gr. 5
48	532 15 44-07	Bellcrank Asm	165	532 16 56-23	Bracket Pivot Lever
49	532 12 32-05	Retainer Belt Style Spring	166	817 49 05-10	Screw 5/16-18 x 5/8
50	872 11 06-12	Bolt Carr Sh 3/8-16 x 1-1/2 Gr. 5	168	532 16 54-92	Bolt Shoulder 5/16-18 x .561
51	873 68 06-00	Nut Crownlock 3/8-16 unc	169	532 16 55-80	Plate Fastening Lt
52	873 68 05-00	Nut Crownlock 5/16-18 unc	170	532 18 74-14	Keeper Belt T/A
53	532 10 57-10	Link Clutch	197	532 16 96-13	Nyliner, Snap - in
55	532 10 57-09	Spring Return Clutch 6 75	198	532 16 95-93	Washer, Nyl.
56	817 06 06-20	Screw 3/8-16 x 1-1/4	202	872 11 06-14	Bolt, 3/8 - 16 x 1-3/4 Gr. 5
57	532 13 08-01	V-Belt Ground Drive	212	532 14 52-12	Nut Flange Hex Lock
59	532 16 96-91	Keeper Belt Span Ctr			
61	817 12 06-14	Screw 3/8-16 x .875			

**NOTE:** All component dimensions given in U.S. inches  
1 inch = 25.4 mm



# REPAIR PARTS

TRACTOR -- MODEL NUMBER MC1538ST (MC1538STA), PRODUCT NO. 964 77 28-03

## STEERING

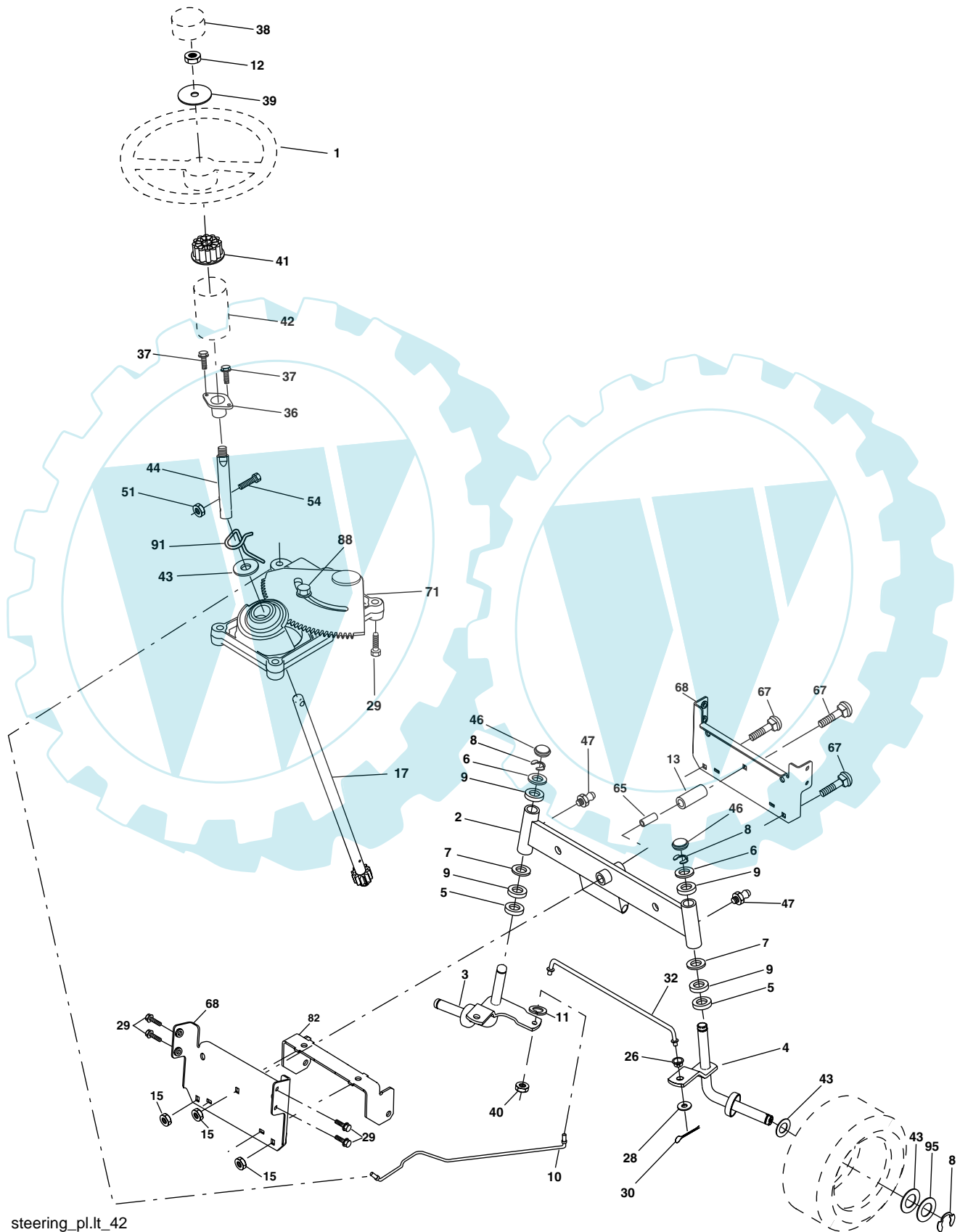

steering\_pl.lt\_42

## REPAIR PARTS

TRACTOR -- MODEL NUMBER MC1538ST (MC1538STA), PRODUCT NO. 964 77 28-03  
STEERING

KEY NO.	PART NO.	DESCRIPTION
1	532 13 97-68	Wheel Steering Opp. Sears Blk
2	532 17 51-31	Axle Asm Fr
3	532 16 98-40	Spindle Asm LH
4	532 16 98-39	Spindle Asm RH
5	532 12 49-31	Bearing Race Thrust Harden
6	532 12 17-48	Washer 25/32 x 1-5/8 x 16 Ga.
7	819 27 20-16	Washer 27/32 x 1-1/4 x 16 Ga.
8	812 00 00-29	Ring Klip #t5304-75
9	532 12 49-37	Bearing Col Strg Blk
10	532 17 51-21	Link Drag
11	810 04 06-00	Washer Lock Hvy Hlcl Spr 3/8
12	873 94 08-00	Nut Hex Jam Toplock 1/2-20 unf
13	532 13 65-18	Spacer Brace Axle
15	532 14 52-12	Nut Hexflange Lock
17	532 18 06-41	Shaft Asm Strg
26	532 12 68-47	Bushing Link Drag Blk LR
28	819 13 14-16	Washer 13/32 x 7/8 x 16 Ga.
29	817 00 06-12	Screw 3/8-16 x .75
30	876 02 04-12	Pin Cotter 1/8 x 3/4 Cad
32	532 13 04-65	Rod Tie Wire Form 19 75 Mech
36	532 15 50-99	Bushing Strg Nat .623/.618ld
37	532 15 29-27	Screw TT #10-32 x 5 x 3/8 Flange
38	532 14 01-75	Cap Wheel Steer P/L
39	819 18 38-12	Washer 19/16 ID x 2-3/8 OD 12 Ga.
40	873 54 06-00	Nut Crownlock 3/8-24
41	532 18 67-37	Adaptor Wheel Strg
42	532 16 96-33	Boot Shaft Steering
43	532 12 17-49	Washer 25/32 x 1 1/4 x 16 Ga.
44	532 18 06-40	Extension Steering
46	532 12 12-32	Cap Spindle Fr Top Blk
47	532 18 32-26	Fitting Grease
51	873 54 04-00	Nut Crownlock 1/4-28
54	871 13 04-20	Bolt Hex 1/4-28 unf x 1-1/4 Gr. 8
65	532 16 03-67	Spacer Brace Axle
67	872 11 06-18	Bolt RDHD SQ 3/8-16 unc x 2-1/4
68	532 16 98-27	Brace Axle
71	532 17 51-46	Steering Asm.
82	532 16 98-35	Bracket Susp. Chassis Front
88	532 17 51-18	Bolt Shoulder 7/16-20
91	532 17 55-53	Clip Steering
95	532 18 89-67	Washer Harden .793 x 1.637 x 060

**NOTE:** All component dimensions given in U.S. inches  
1 inch = 25.4 mm.

# REPAIR PARTS

TRACTOR -- MODEL NUMBER MC1538ST (MC1538STA), PRODUCT NO. 964 77 28-03  
ENGINE

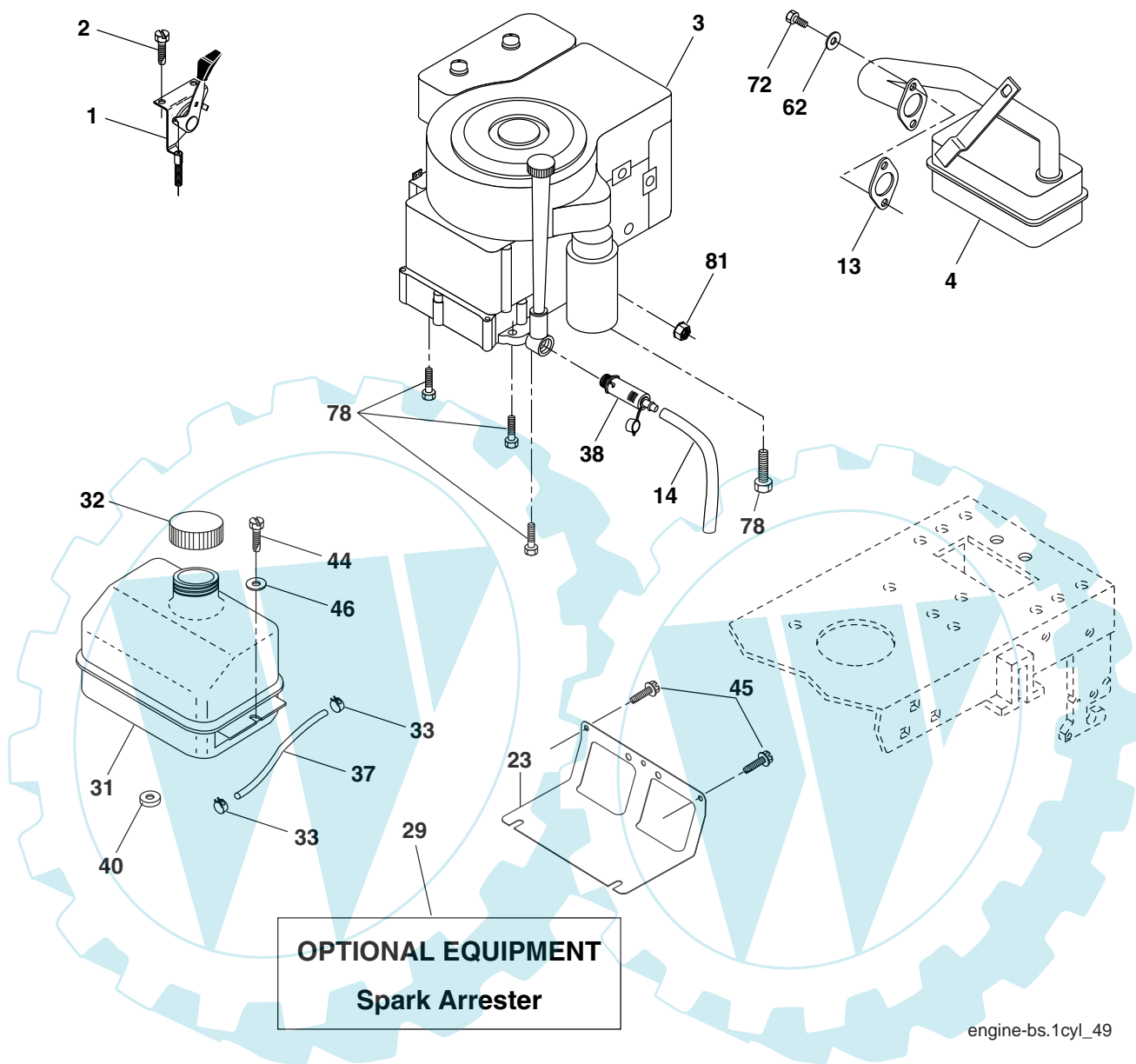

engine-bs.1cyl\_49

KEY NO.	PART NO.	DESCRIPTION
1	532 17 05-51	Control Throttle /Choke
2	817 72 04-08	Screw Hex Thd Cut 1/4-20 x 5/8 T
3	-----	Engine Briggs Model 281H07 (Order Parts from Engine Manufacturer)
4	532 13 73-52	Muffler Exhaust
13	532 16 52-91	Gasket
14	532 14 84-56	Tube Drain Oil Easy
23	532 16 98-37	Shield Browning/Debris Guard
29	532 13 71-80	Arrestor Spark
31	532 18 49-00	Tank Fuel
32	532 14 05-27	Cap Asm Fule Top Vent N/Lany
33	532 12 34-87	Clamp Hose Blk

KEY NO.	PART NO.	DESCRIPTION
37	532 13 70-40	Line Fuel 20"
38	532 18 16-54	Plug Drain Oil Easy
40	532 12 40-28	Bushing Snap
44	817 67 04-12	Screw Hexwsh Thdrol 3/8-16 x 3/4
45	817 00 06-12	Screw 3/8-16 x 3/4
46	819 09 14-16	Washer 9/32 x 7/8 x 16 Ga.
62	810 01 05-00	Washer Split
72	817 07 05-12	Screw Hex Head Cap 5/16-18 x 3/8
78	817 06 06-20	Screw 3/8-16 x 1-1/4
81	873 51 04-00	Nut Keps Hex 1/4-20 unc

**NOTE:** All component dimensions given in U.S. inches  
1 inch = 25.4 mm

# REPAIR PARTS

TRACTOR -- MODEL NUMBER MC1538ST (MC1538STA), PRODUCT NO. 964 77 28-03  
SEAT

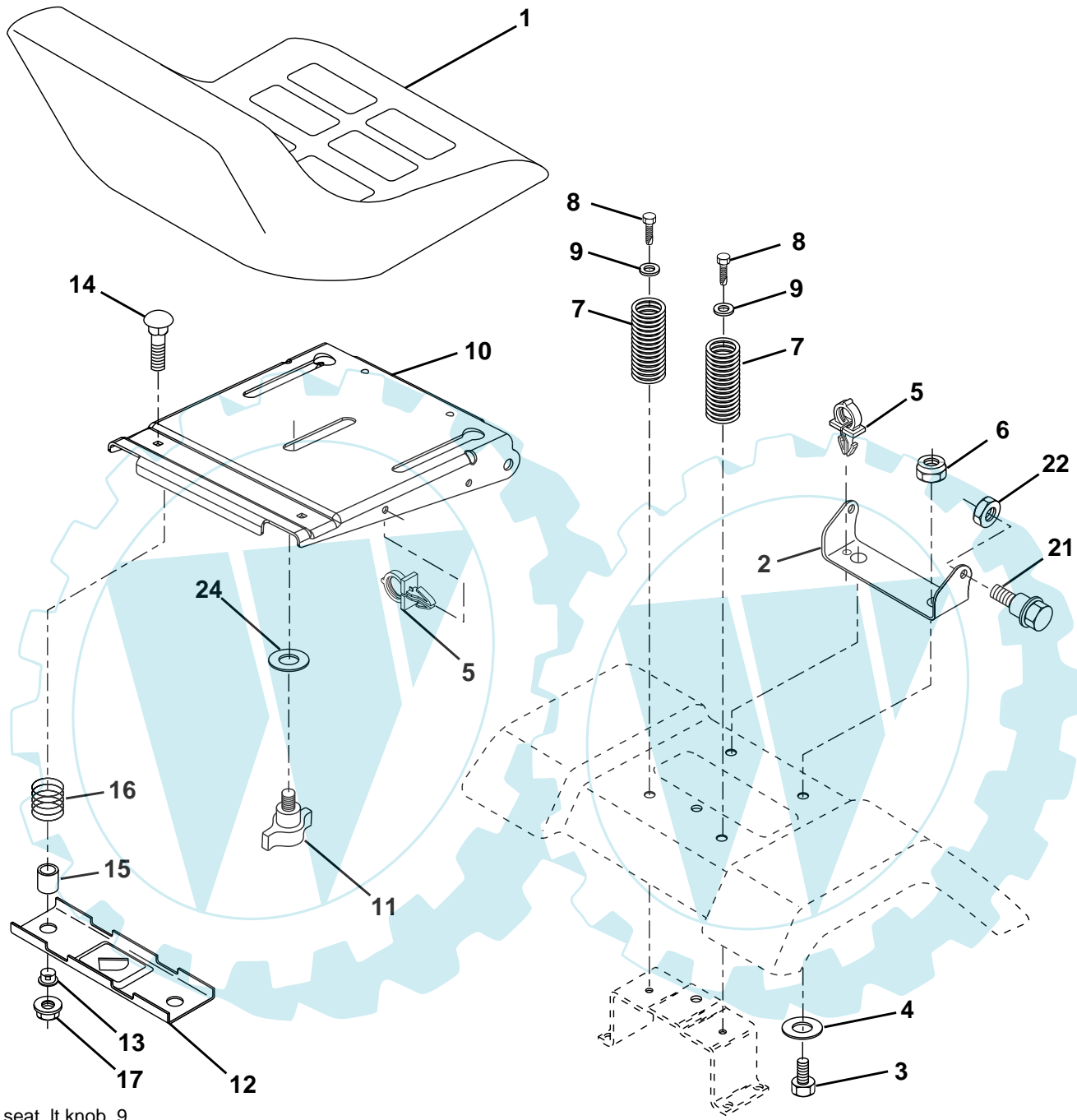

seat\_lt.knob\_9

KEY NO.	PART NO.	DESCRIPTION
1	532 18 87-04	Seat
2	532 18 01-66	Bracket Pivot
3	871 11 06-16	Bolt Fin Hex 3/8-16 unc x 1
4	819 13 16-10	Washer 13/32 x 1 x 10 Ga.
5	532 14 50-06	Clip Push-In
6	873 80 06-00	Nut Lock Hex w/Wsh 3/8-16 unc
7	532 12 41-81	Spring Seat Cprsn 2 250 Blk Zi
8	817 00 06-16	Screw 3/8-16 x 1.5
9	819 13 16-14	Washer 13/32 x 1 x 14 Ga.
10	532 18 01-86	Pan Seat
11	532 16 63-69	Knob Seat

KEY NO.	PART NO.	DESCRIPTION
12	532 12 12-46	Bracket Mounting Switch
13	532 12 12-48	Bushing Snap Blk Nyl 50 Id
14	872 05 04-12	Bolt Rdhd Sht Nk 1/4-20 x 1-1/2
15	532 13 43-00	Spacer Split 28x 96 Yel Zinc
16	532 12 12-50	Spring Cprsn 1 27 Blk Pnt
17	532 12 39-76	Nut Lock 1/4 Lge Flg Gr. 5 Zinc
21	532 17 18-52	Bolt Shoulder 5/16-18 unc -2A
22	873 80 05-00	Nut Lock Hex W/Insert 5/16-18 unc
24	819 17 19-12	Washer 17/32 x 1-3/16 x 12 Ga.

**NOTE:** All component dimensions given in U.S. inches.  
1 inch = 25.4 mm

# REPAIR PARTS

TRACTOR -- MODEL NUMBER MC1538ST (MC1538STA), PRODUCT NO. 964 77 28-03  
DECALS

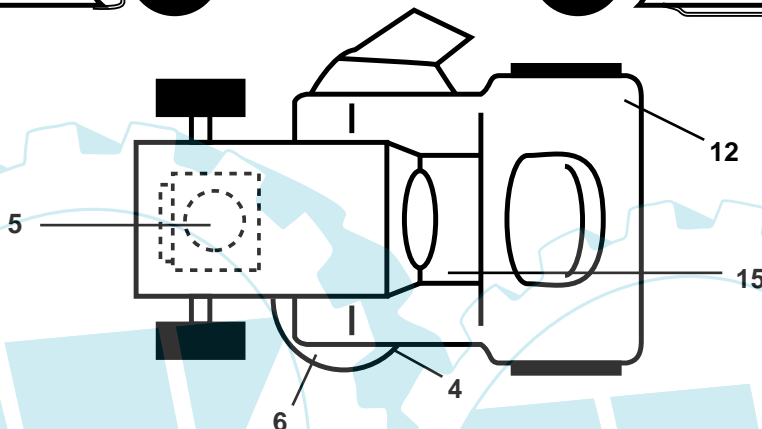
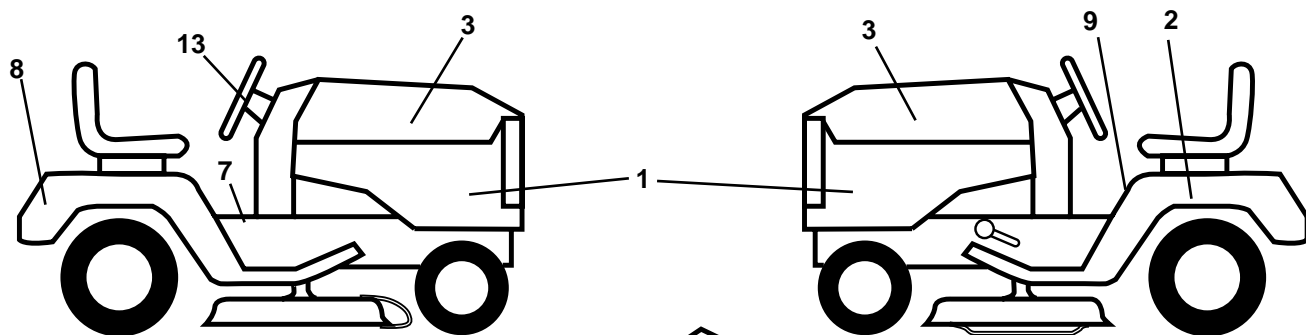

KEY NO.	PART NO.	DESCRIPTION
1	532 19 40-77	Decal Side Panel
2	532 14 50-05	Decal Bat Dan/Poi P/L Symbols
3	532 19 32-03	Decal Hood
4	532 13 68-32	Decal Schematic
5	532 18 47-68	Decal Engine
6	532 18 12-49	Decal Clutch Brake
7	532 15 70-02	Decal Fender Danger

KEY NO.	PART NO.	DESCRIPTION
8	532 19 32-07	Decal Fender
12	532 16 88-69	Decal Tick Mark
13	532 18 58-81	Decal Strg Wheel Cap
15	532 15 68-67	Decal Operator's
--	532 13 83-11	Decal Lift Handle (Lift Handle)
--	532 19 31-86	Manual Owner's

## WHEELS & TIRES

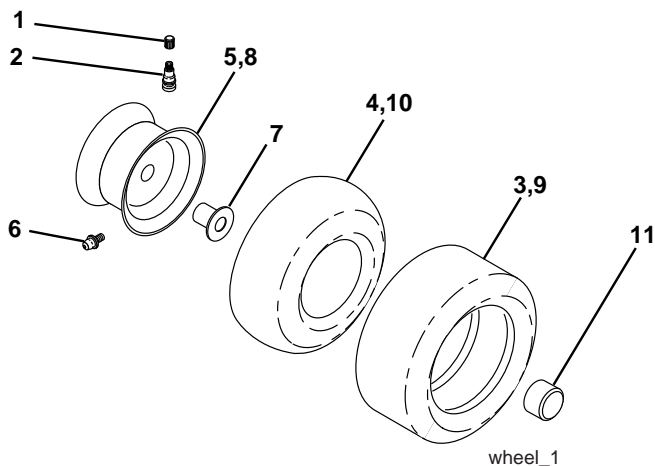

KEY NO.	PART NO.	DESCRIPTION
1	532 05 91-92	Cap Valve Tire
2	532 06 51-39	Stem Valve
3	532 12 41-57	Tire F Ts 15 x 6.0 - 6 Service
4	532 05 99-04	Tube Front (Service Item Only)
5	532 12 51-21	Rim Asm 6" front Service
6	532 12 49-57	Fitting Grease (Front Wheel Only)
7	532 12 49-59	Bearing Flange (Front Wheel Only)
8	532 12 51-22	Rim Asm 8" rear Service
9	532 12 39-69	Tire R Ts 18 x 8.5-8 C. Service
10	532 12 49-26	Tube Rear (Service Item Only)
11	532 17 50-39	Cap Axle Blk 1 50 x 1 00

**NOTE:** All component dimensions given in U.S. inches  
1 inch = 25.4 mm



# REPAIR PARTS

TRACTOR -- MODEL NUMBER MC1538ST (MC1538STA), PRODUCT NO. 964 77 28-03  
MOWER LIFT

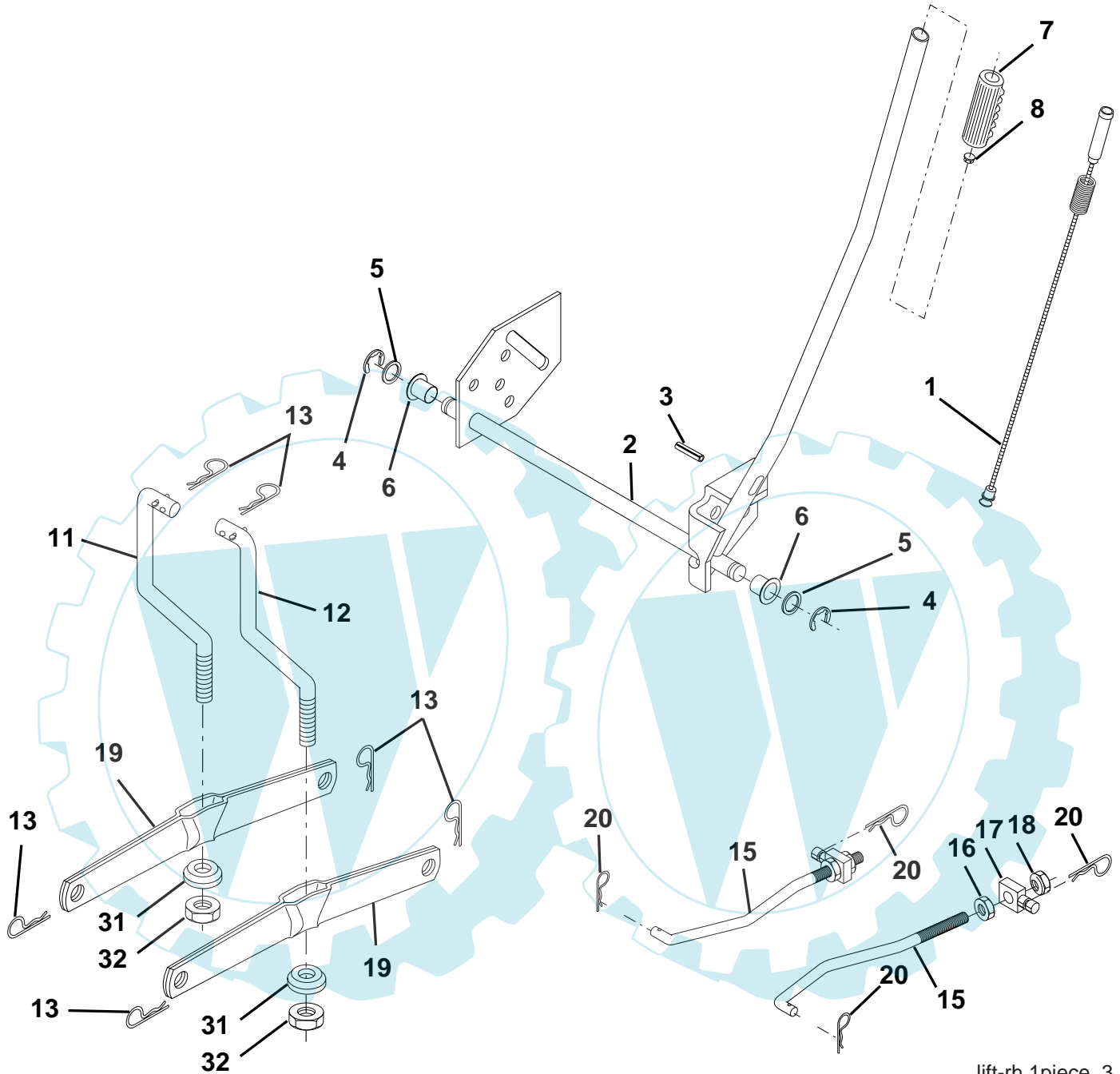

lift-rh.1piece\_3

KEY NO.	PART NO.	DESCRIPTION
1	532 15 94-61	Wire Asm Inner W/Plunger
2	532 15 94-76	Shaft Asm Lift
3	532 18 88-22	Pin Groove
4	812 00 00-02	E Ring #5133-62
5	819 21 16-21	Washer PLTD 21/32 x 1 x 21 Ga.
6	532 12 01-83	Bearing Nylon Blk 629 Id
7	532 10 94-13	Grip Handle Bicycle Matte Blk
8	532 12 45-26	Button Plunger Black
11	532 13 98-65	Link Lift LH
12	532 13 98-66	Link Lift RH

KEY NO.	PART NO.	DESCRIPTION
13	532 12 46-70	Retainer Spring
15	532 17 32-88	Link Front
16	873 35 08-00	Nut Jam Hex 1/2-13 unc
17	532 17 56-89	Trunnion
18	873 80 08-00	Nut Lock w/wsh 1/2-13 unc
19	532 13 98-68	Arm Suspension Rear
20	532 16 35-52	Retainer Spring
31	532 16 98-65	Bearing Pvt Lift
32	873 54 06-00	Nut Crownlock 3/8-24

**NOTE:** All component dimensions given in U.S. inches  
1 inch = 25.4 mm

# REPAIR PARTS

TRACTOR -- MODEL NUMBER MC1538ST (MC1538STA), PRODUCT NO. 964 77 28-03  
MOWER DECK

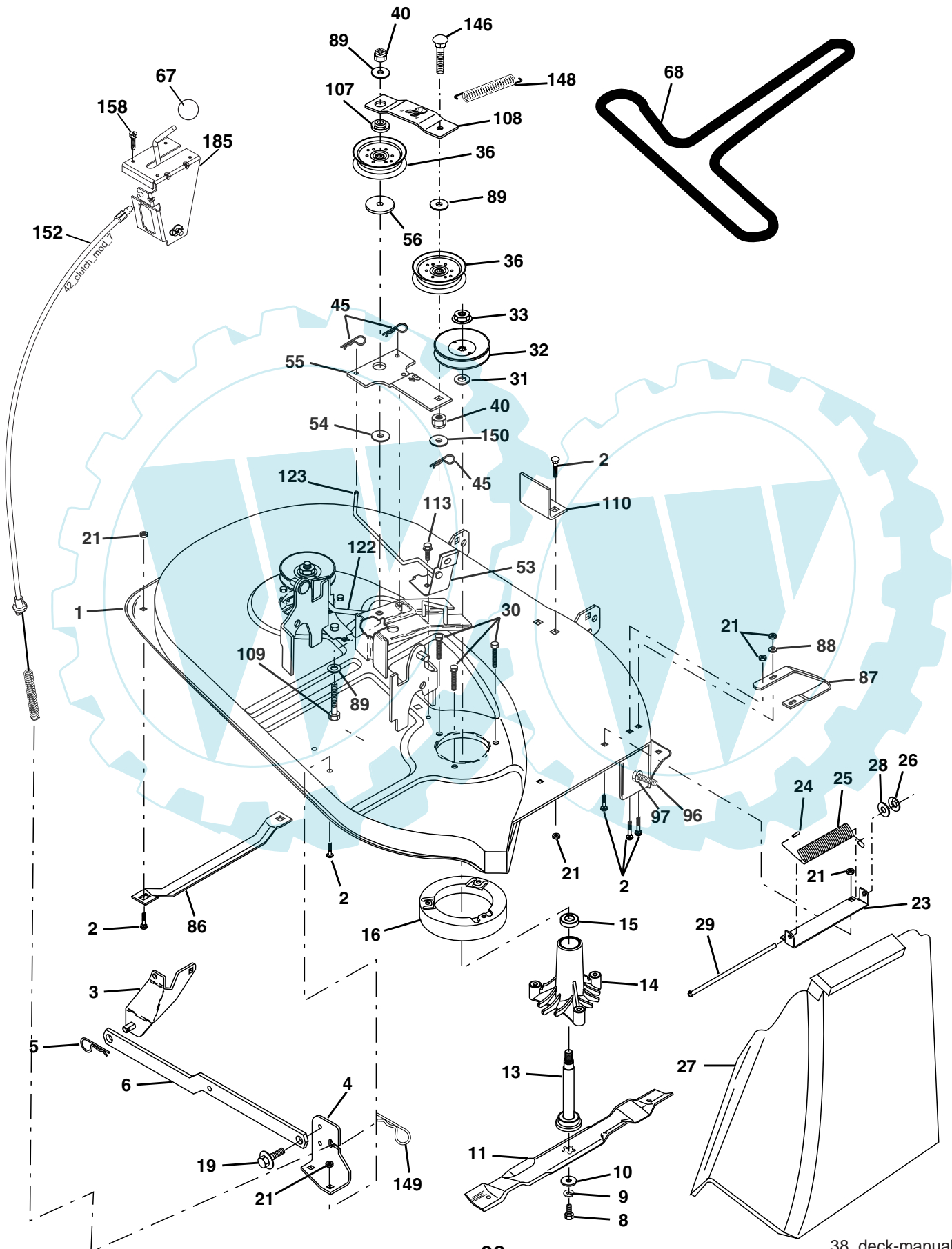

# REPAIR PARTS

**TRACTOR - - MODEL NUMBER MC1538ST (MC1538STA), PRODUCT NO. 964 77 28-03  
MOWER DECK**

KEY NO.	PART NO.	DESCRIPTION
1	532 17 02-80	Mower Housing Assembly
2	872 14 05-06	Bolt Carriage 5/16-18 x 3/4
3	532 13 80-17	Bracket Asm Fr. Sway Bar
4	532 16 99-70	Bracket Deck Sway Bar 38"/42"
5	532 12 46-70	Retainer Spring
6	532 17 80-24	Sway Bar Deck
8	532 85 08-57	Bolt 3/8-24 x 1.25 Gr. 8
9	810 03 06-00	Washer, Lock 3/8
10	532 14 02-96	Washer, Hardened
11	532 13 84-97	Blade Mower
13	532 13 76-45	Shaft Assembly, Mandrel, Vented (Includes Key Number 6)
14	532 12 87-74	Housing, Mandrel, Vented
15	532 11 04-85	Bearing, Ball, Mandrel
16	532 17 44-93	Stripper, Mower Deck
19	532 13 28-27	Bolt, Shoulder
21	873 68 05-00	Nut
23	532 13 76-07	Bracket, Mower Deflector
24	532 10 53-04	Cap, Sleeve
25	532 12 37-13	Spring, Torsion, Deflector
26	532 11 04-52	Nut, Push
27	532 17 59-43	Shield, Deflector
28	819 11 10-16	Washer 11/32 x 5/8 x 16 Ga.
29	532 10 67-35	Rod, Hinge
30	532 17 39-84	Screw Thdrol. Hex
31	532 18 76-90	Washer, Spacer
32	532 15 35-32	Pulley, Mandrel
33	532 17 83-42	Nut, Toplock
36	532 13 14-94	Pulley, Idler, Flat
40	873 68 06-00	Nut, Crownlock 3/8-16 unc
45	532 12 47-88	Retainer
53	532 13 08-40	Brake Assembly
54	532 17 85-15	Washer, Hardened

KEY NO.	PART NO.	DESCRIPTION
55	532 13 38-40	Idler Arm Assembly
56	532 16 57-23	Spacer, Retainer
67	532 10 69-32	Knob
68	532 14 42-00	V-Belt
69	532 12 47-88	Retainer Spring
86	532 12 50-74	Runner, LH
87	532 12 87-72	Runner, RH
88	819 11 12-16	Washer 11/32 x 3/4 x 16 Ga.
89	819 13 13-11	Washer 13/32 x 13/16 x 11 Ga.
96	874 93 06-20	Bolt 3/8-16 x 1-1/4
97	873 93 06-00	Nut Centerlock 3/8-16 unc
107	532 13 35-02	Spacer Retainer
108	532 13 35-03	Stiffener, Idler Arm
109	874 76 06-40	Bolt, Hex Hd 3/8-16 x 2-1/2
110	532 14 25-87	Upstop Deck Front 38"
113	817 06 05-12	Screw 5/16-1/ x 3/4
122	532 13 12-89	Rod, Brake LH
123	532 16 99-71	Rod, Brake RH
146	532 16 58-91	Bolt Carriage Idler
148	532 16 90-22	Spring Return Idler
149	532 16 58-98	Retainer Spring Yellow
150	819 09 12-10	Washer 9/32 x 3/4 x 10 Ga.
152	532 17 27-58	Clutch Cable 38"/46"
158	817 72 04-08	Screw Hex Thd Cut 1/4-20 x 5/8
185	532 18 82-34	Head Asm. Cable Clutch
--	532 13 07-94	Mandrel Assembly (Includes Housing, Shaft, and Shaft Hardware Only - Pulley Not Included)
--	532 17 03-17	Mower Replacement, Complete

**NOTE:** All component dimensions given in U.S. inches  
1 inch = 25.4 mm

---

# SERVICE NOTES

---

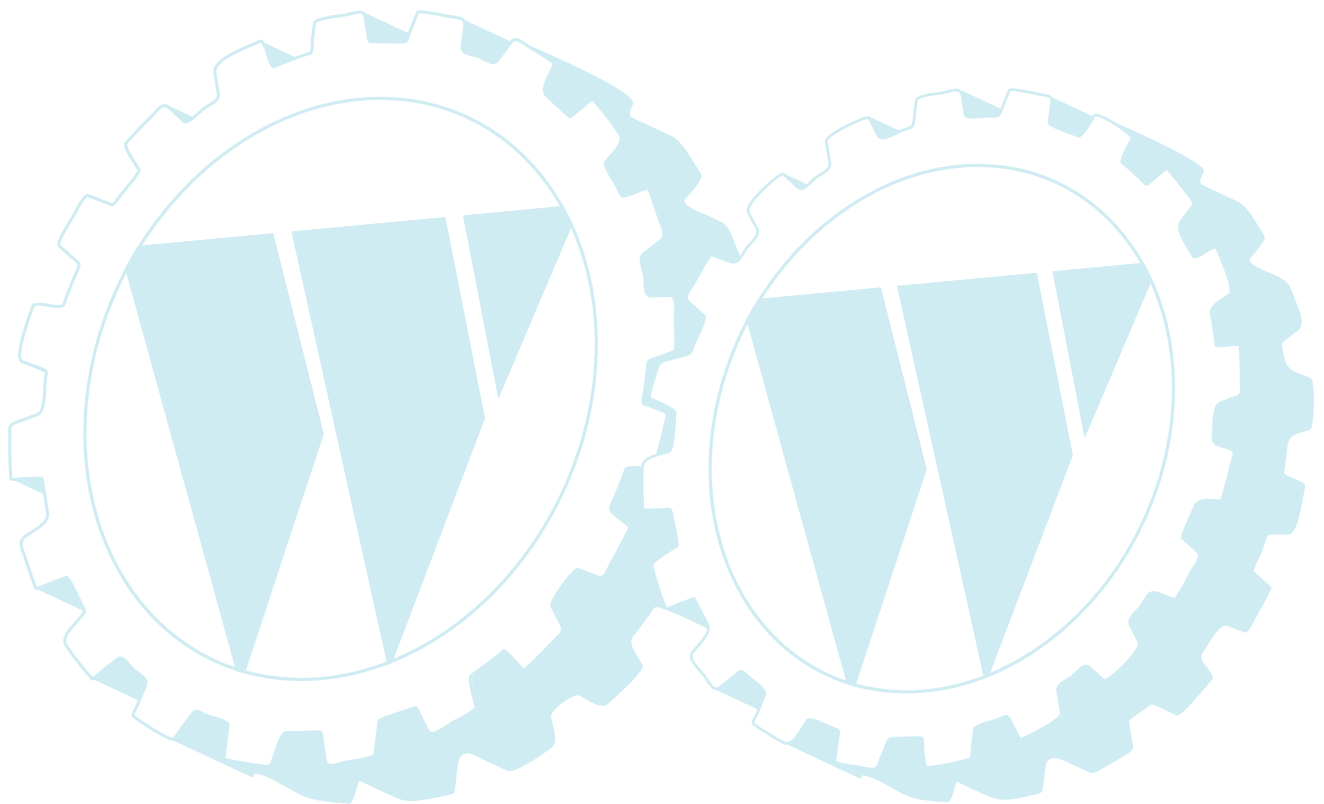

---

# SERVICE NOTES

---

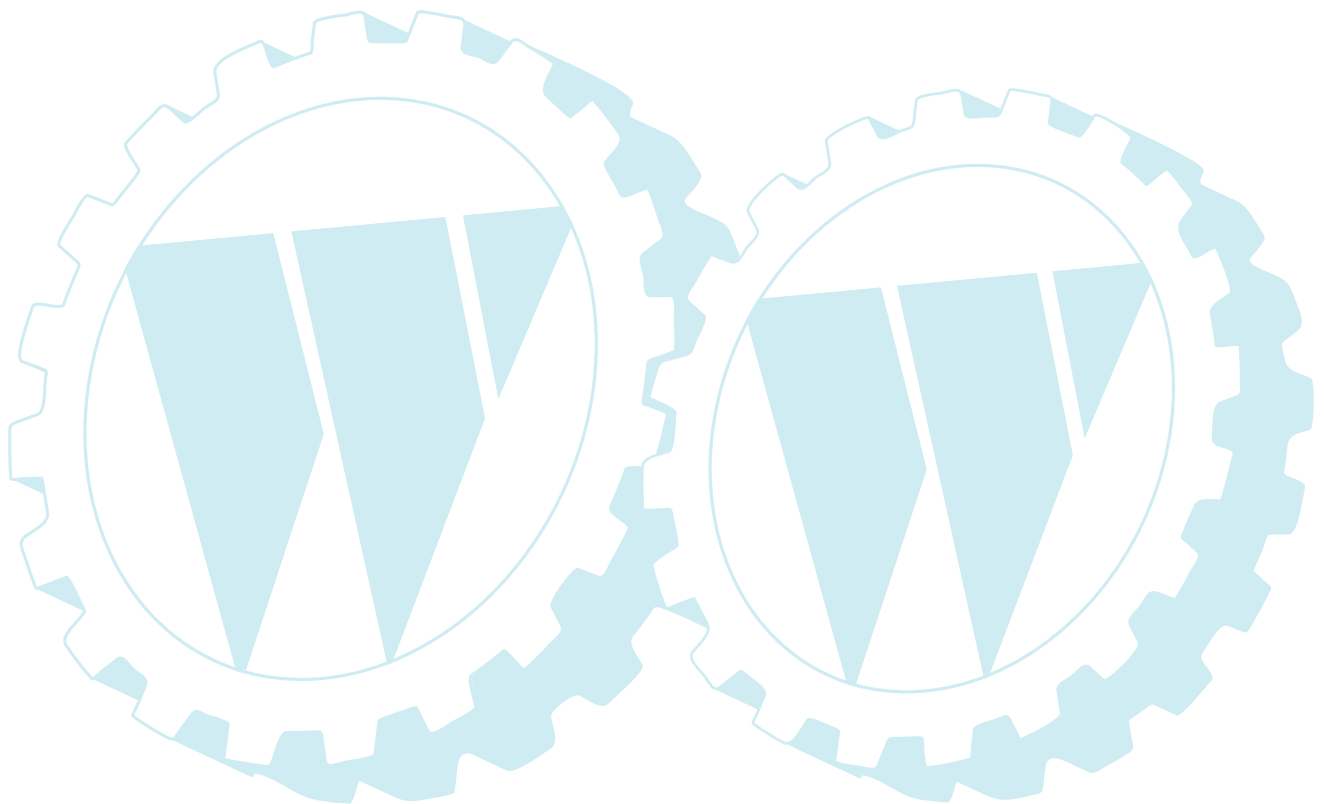





TECUMSEH

Issued January 1980  
Revised January 1991

# SERVICE POLICY WARRANTY

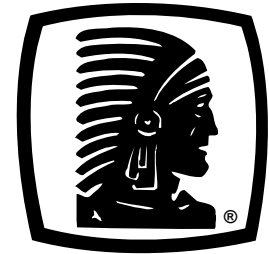

TECUMSEH

## LIMITED WARRANTIES FOR NEW PEERLESS GEAR POWER TRAIN COMPONENTS

### A. Products Warranted

Peerless Gear and Machine Division of Tecumseh Products Company ("Tecumseh"), subject to the limitations contained below, will, at its option, repair or replace, without charge for parts or labor only, any part of a new Power Train Component (which as used herein means and includes the transaxle, gear box, transmission, differential and right angle drives, and any part of the Power Train Component), EXCEPT any new Power Train Component incorporated in equipment used for commercial or rental purposes, which is found upon examination by any Tecumseh Authorized Service Outlet or by Tecumseh's factory in Grafton, Wisconsin, to be DEFECTIVE IN MATERIAL AND/OR WORKMANSHIP if received by Tecumseh or a Tecumseh Authorized Service Outlet for such examination within TWO YEARS from the date of sale to the original consumer purchaser of Peerless Series 820, 900, 910, 915, 920, 930 transaxles and Series 1100 angle drive and ONE YEAR for all other Peerless products. New Power Train Components incorporated in equipment used for commercial purposes are warranted in the same manner and to the same extent EXCEPT such Power Train Components are warranted for NINETY (90) DAYS ONLY, and must be received by Tecumseh or a Tecumseh Authorized Service Outlet for such examination within 90 days from the date of sale to the original purchaser. New Power Train Components Incorporated in equipment used for rental purposes are warranted in the same manner and to the same extent EXCEPT such Power Train Components are warranted for THIRTY (30) DAYS ONLY, and must be received by Tecumseh or a Tecumseh Authorized Service Outlet within 30 days from the date of sale to the original purchaser.

### B. Products And Items Not Warranted

1. Alterations or Modifications of Power Train Components.
2. Accidents, Normal Maintenance, Failure to follow the Original Equipment Manufacturer's Manual.

This warranty covers only parts of new Power Train Components which are found upon examination to be defective in material or workmanship as delivered to the original purchaser. This warranty does not cover defects caused by depreciation or damage caused by normal wear, accidents, improper maintenance, improper use or abuse of the product, failure to follow the instructions contained in an Instruction Manual for the operation of the Power Train Component and parts. The cost of normal maintenance and replacement of service items which are not defective shall be paid for by the original purchaser.

### C. Securing Warranty Service

Warranty service can be arranged for by contacting either a Tecumseh Authorized Service Outlet (any Tecumseh Registered Service Dealer, Tecumseh Authorized Service Distributor, or Tecumseh Central Warehouse Distributor) or by contacting Tecumseh, c/o Service Manager, Engine and Transmission Group Service Division, 900 North Street, Grafton, Wisconsin 53024. Warranty service can only be performed by a Tecumseh Authorized Service Outlet or by Tecumseh at its factory in Grafton, Wisconsin. At the time of requesting warranty service, evidence must be presented of the date of sale to the original purchaser. The purchaser shall pay any charges for making service calls and/or for transporting the product to and from the place where the inspection and/or warranty work is performed. The purchaser shall be responsible for any damage or loss incurred in connection with the transportation of Power Train Components and/or part(s) of the Power Train Components submitted for inspection and/or warranty work.

### D. Limitation of Damages and Implied Warranties

The foregoing EXPRESSED WARRANTY IS IN LIEU OF ALL OTHER EXPRESS WARRANTIES. Neither Tecumseh nor any of its affiliates makes any warranties, representations or promises, written or oral, as to the quality of the Power Train Component or any of its parts, other than as set forth herein.

ANY IMPLIED WARRANTY OF MERCHANTABILITY OR FITNESS FOR A PARTICULAR PURPOSE, TO THE EXTENT THAT EITHER MAY APPLY TO ANY PART(S) OF POWER TRAIN COMPONENTS, SHALL BE LIMITED IN DURATION TO THE PERIODS OF THE EXPRESSED WARRANTIES DEFINED IN PARAGRAPH A HEREOF. IN NO EVENT WILL TECUMSEH BE LIABLE FOR ANY INCIDENTAL, CONSEQUENTIAL OR SPECIAL DAMAGES AND/OR EXPENSES. Some states do not allow limitations on how long an implied warranty lasts or the exclusion or limitation of incidental or consequential damages, so the above limitation(s) or exclusion(s) may not apply to you. This warranty gives you specific legal rights and you may also have other legal rights which vary from state to state.

### E. No Dealer Warranty

Tecumseh neither assumes nor authorizes any other person, natural or corporate, to assume for Tecumseh any other obligations or liabilities in connection with or with respect to any part(s) of a Power Train Component. The seller or dealer of part(s) of a Power Train Component has no authority, whatsoever, to make any representations or promises on behalf of Tecumseh or to modify the terms or limitations of Tecumseh's warranty in any way.

## SUGGESTED GUIDE FOR SIGHTING SLOPES FOR SAFE OPERATION

43

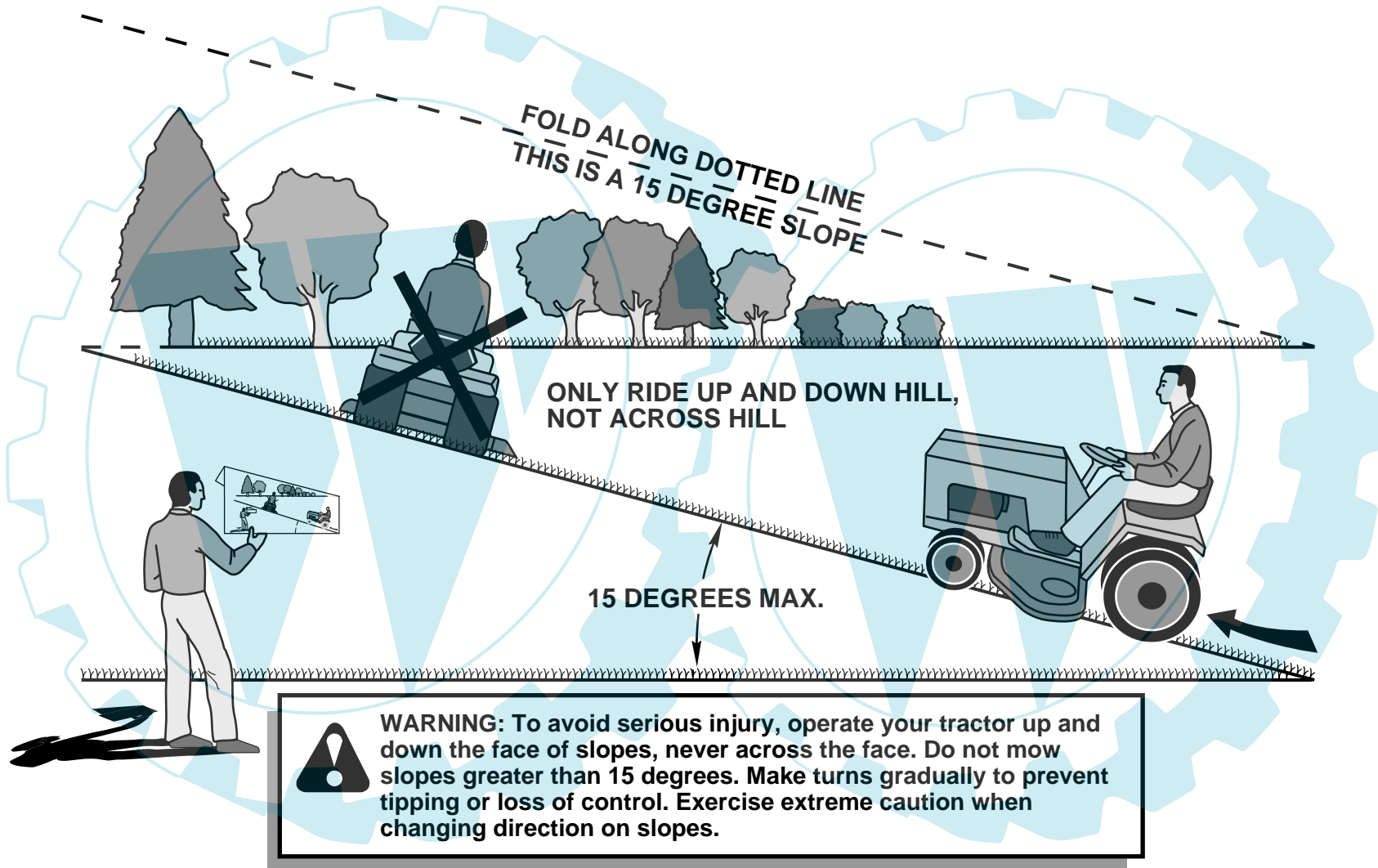

1. Fold this page along dotted line indicated above.
2. Hold page before you so that its left edge is vertically parallel to a tree trunk or other upright structure.
3. Sight across the fold in the direction of hill slope you want to measure.
4. Compare the angle of the fold with the slope of the hill.

